

Straumann® BLX Implant System
Technical information
at a glance.



Dynamic Bone Management

Developed for optimal primary stability and immediate protocols in all bone classes

Full length dynamic chip flute

Collects and condenses native bone chips and distributes them around the implant body

Slim & fully tapered implant core

Allows for small and undersized osteotomy

Bi-directional cutting elements

Designed for reverse and forward cutting control and flexibility during implant insertion

Reduced neck diameter

Designed to reduce stress on crestal bone and to facilitate slightly subcrestal implant placement

Variable thread design

Thin and progressive thread design for high primary stability and efficient insertion





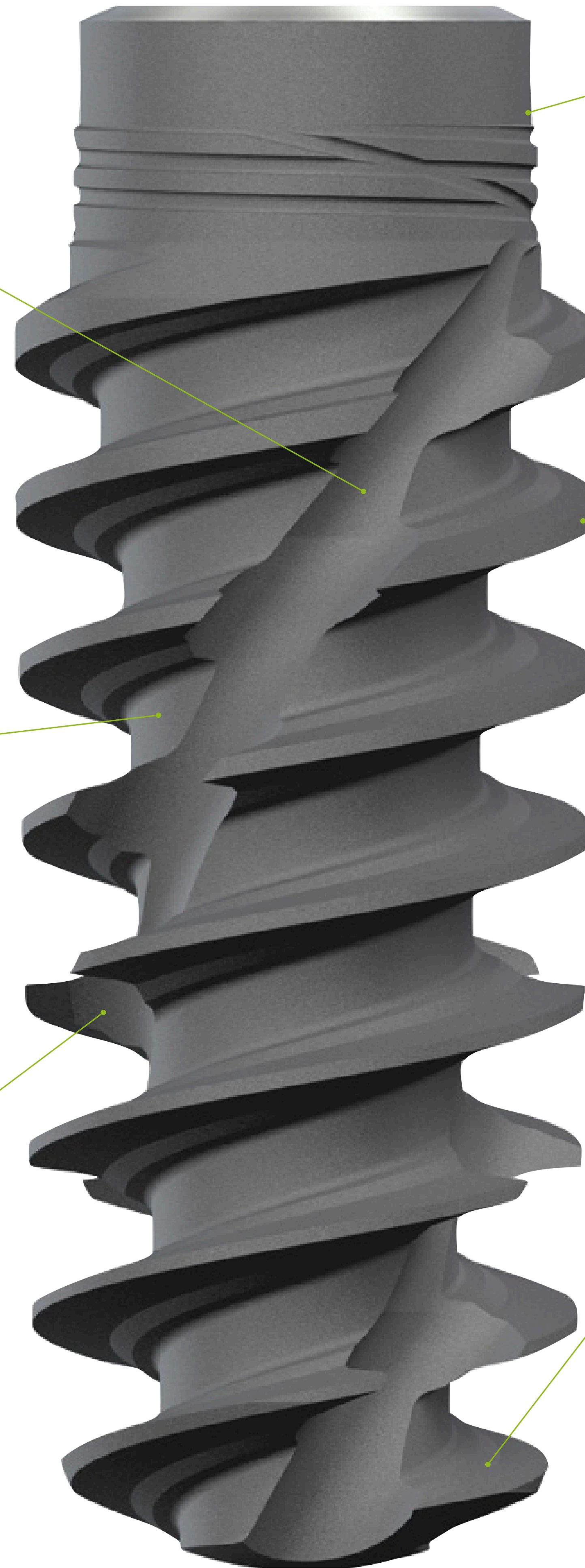



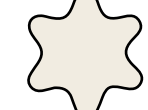

Deep apical threads

Large anchoring surface for immediate engaging and stability

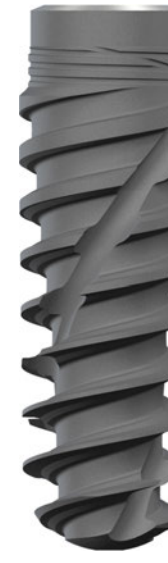
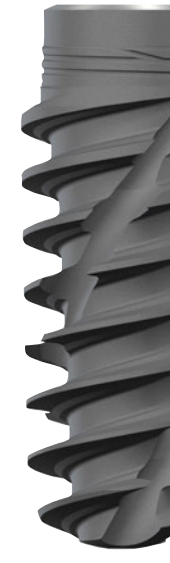
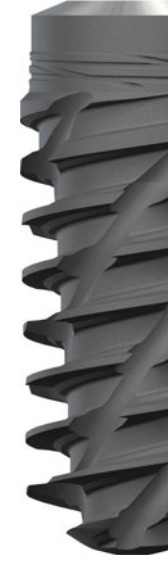
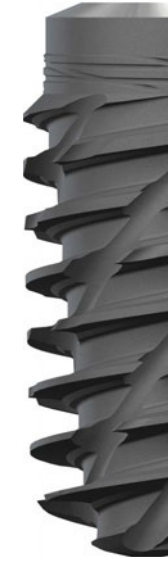

Straumann® BLX Implant portfolio

With BLX Ø 3.75 mm approved for all indications for bone preserving protocols with reduced diameter implants

		Straumann® BLX Implant						
		Ø 3.5 mm	Ø 3.75 mm	Ø 4.0 mm	Ø 4.5 mm	Ø 5.0 mm	Ø 5.5 mm	Ø 6.5 mm
Color code		 (white)	 (red)	 (gray)	 (green)	 (magenta)	 (brown)	 (black)
Prosthetic Base		RB (Regular Base)				WB (Wide Base)		
Connection		TorcFit™						
Picture								
		SLActive®						
Available lengths	6 mm	–	061.4306	061.5306	061.6306	061.7306	061.8306	061.9306
	8 mm	061.3308	061.4308	061.5308	061.6308	061.7308	061.8308	061.9308
	10 mm	061.3310	061.4310	061.5310	061.6310	061.7310	061.8310	061.9310
	12 mm	061.3312	061.4312	061.5312	061.6312	061.7312	061.8312	061.9312
	14 mm	061.3314	061.4314	061.5314	061.6314	061.7314	061.8314	061.9314
	16 mm	061.3316	061.4316	061.5316	061.6316	061.7316	061.8316	061.9316
	18 mm	061.3318	061.4318	061.5318	061.6318	061.7318	–	

TorcFit™ Connection

Internal conical connection engineered for high strength and slim abutment designs

Multi-functional outer shoulder

- High divergence compensation for direct-to-implant bridges
- Wide emergence profiles (optional)
- Precise impression taking

7° Morse taper

- Tight conical sealing
- Slim profile
- High stability in all diameters

Short & strong connection (5mm)

- Allows short implants from 6 mm

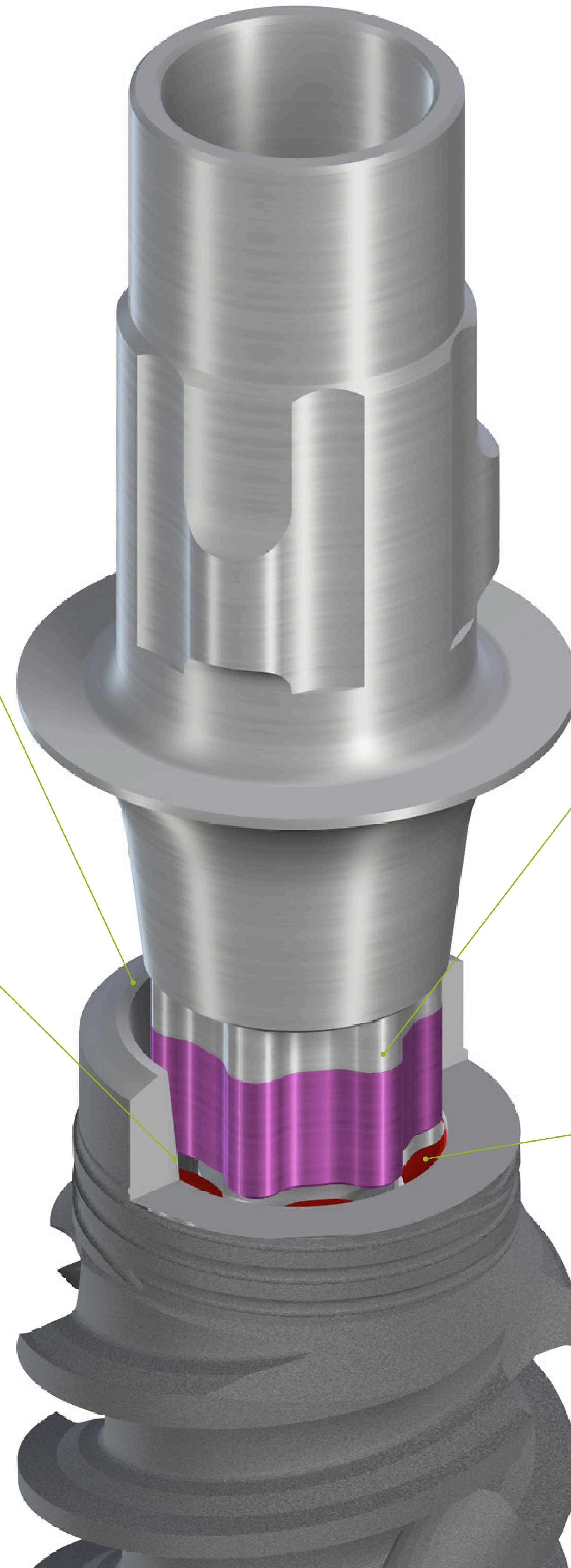

Torx shape











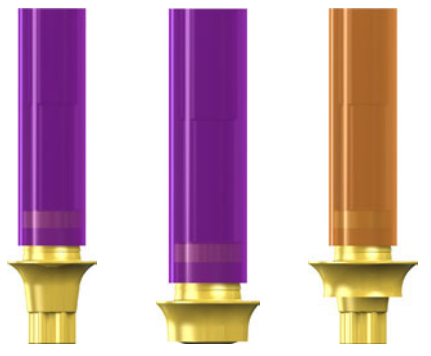

- Flexibility with 6 positions
- Tight/direct torque transmission
- Full depth engagement for high stability

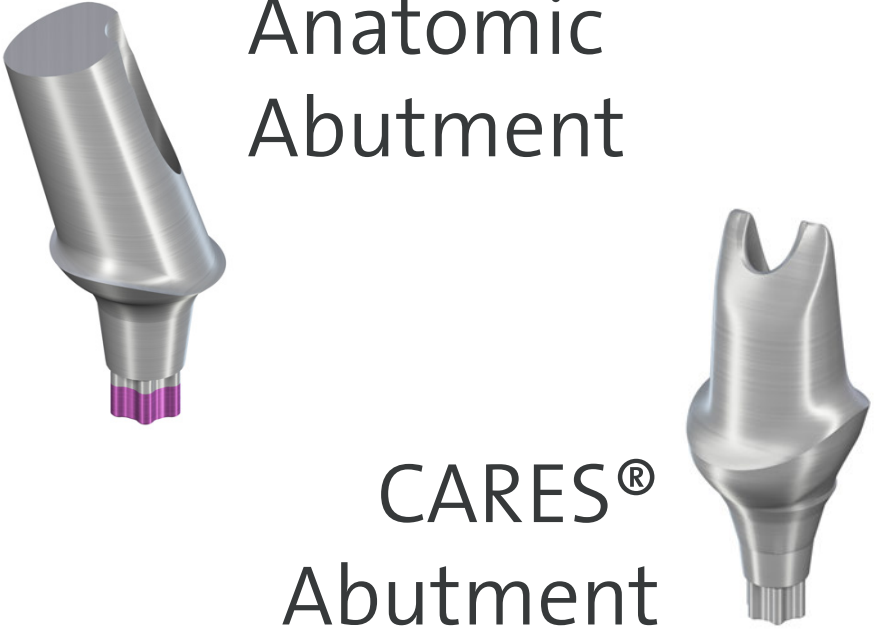
Tactile feedback on correct seating

- Abutment screw engages in implant only if the abutment is correctly seated
- Correctly seated abutments secured by friction fit

Straumann® BLX Prosthetic portfolio

Simple portfolio without compromising on versatility

	Single & Multi-unit		Edentulous			
	Screw-retained	Cement-retained	Fixed		Removable	
Premium	 <p>Gold Abutment, for crown & bridge</p>	 <p>Gold Abutment, for crown & bridge</p>	 <p>CARES® Advanced Fixed Bar</p>		 <p>CARES® Milled Bar</p>	
Advanced	 <p>CARES® Screw-retained Bridge</p>	 <p>Screw-retained Abutment</p>	 <p>Anatomic Abutment CARES® Abutment</p>	 <p>CARES® Screw- retained Bridge</p>	 <p>Screw- retained Abutment</p>	 <p>Anatomic Abutment CARES® Milled Bar</p>
Standard	 <p>Variobase® Straight Bar/Bridge Angulated Variobase C*</p>	 <p>Variobase® Straight Bar/Bridge Angulated C*</p>	 <p>Variobase® Bar/Bridge</p>		 <p>Novaloc® Abutment</p>	 <p>Screw- retained Abutment</p>

* for Sirona CEREC workflow





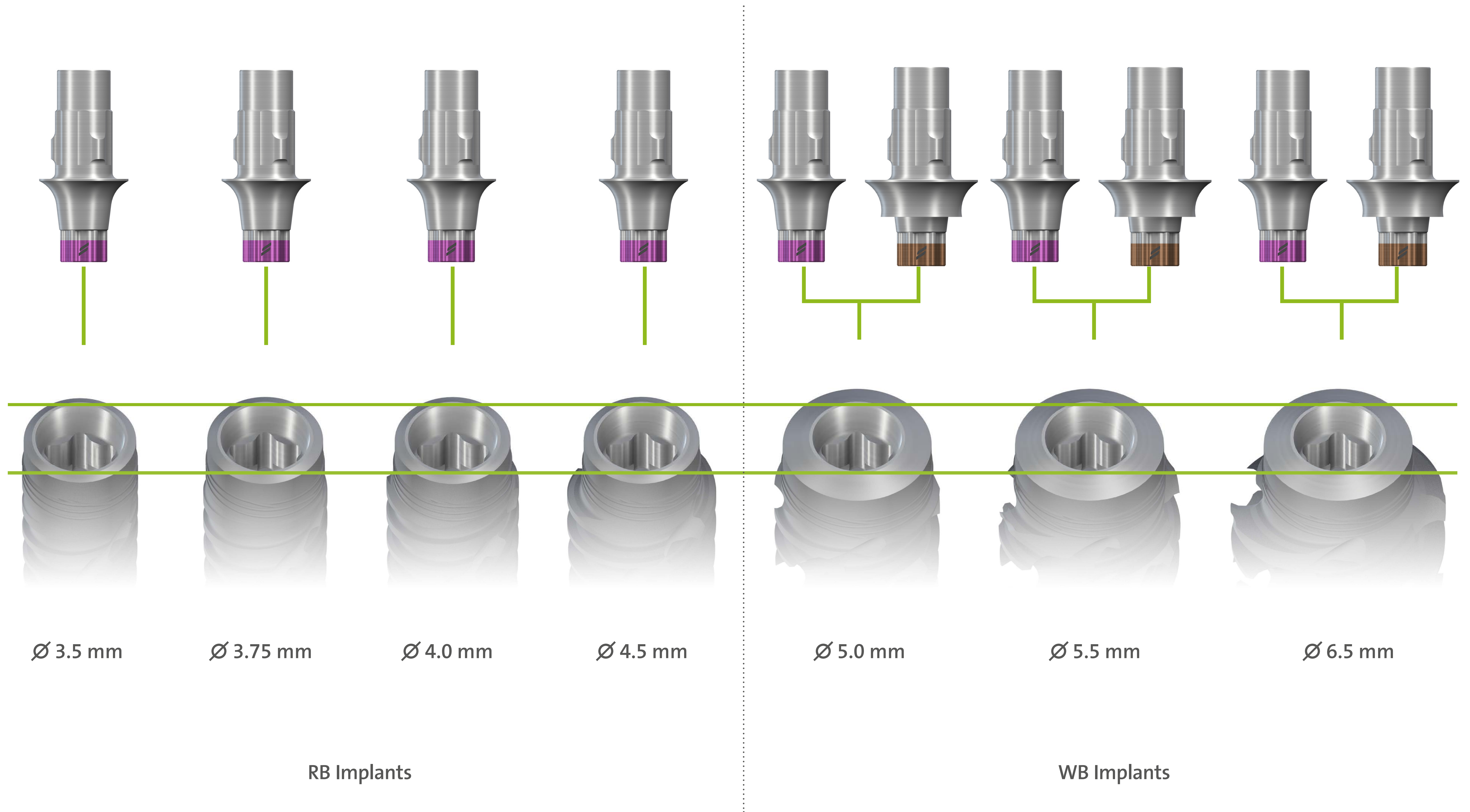

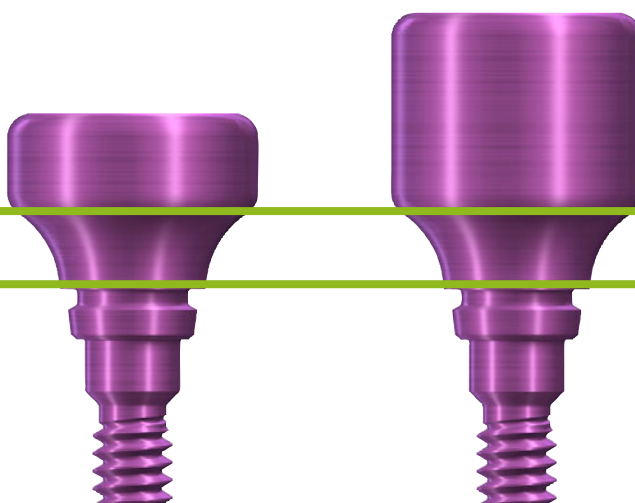

One connection for simplified workflows

Fewer components, reduced surgical and restorative complexity thanks to one connection for all implant diameters

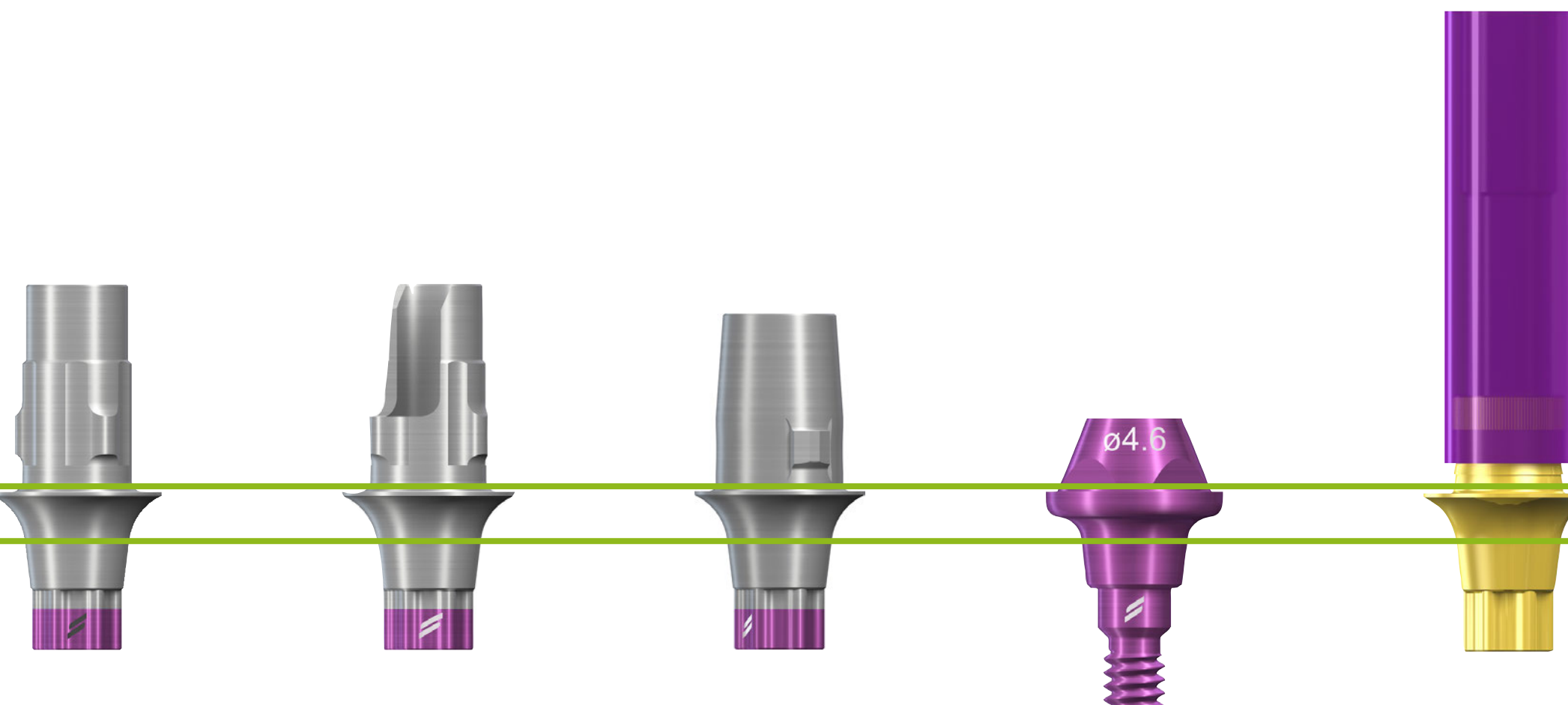

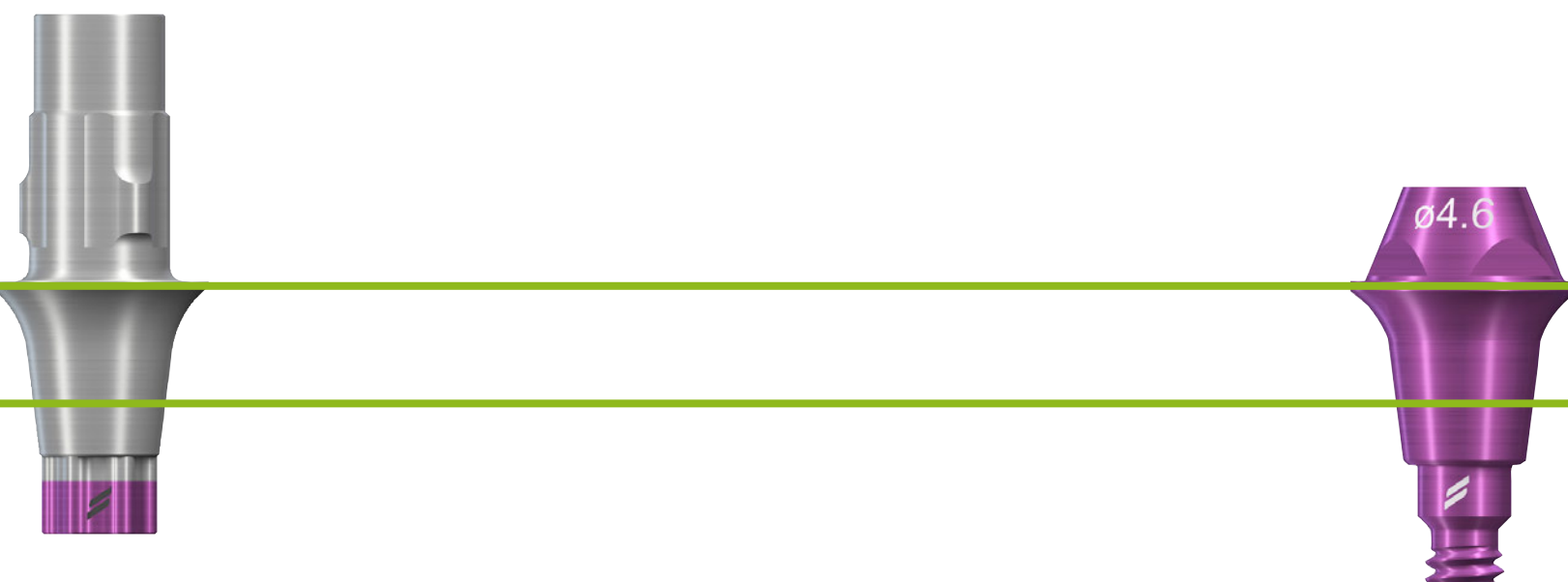
Consistent Emergence Profiles™

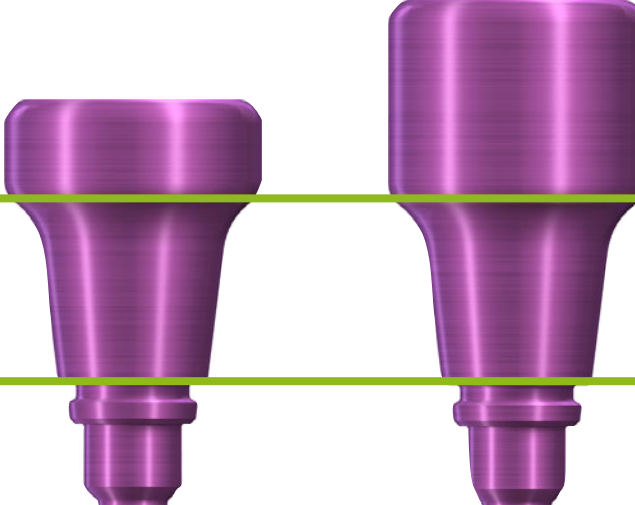
Matching components for straightforward soft tissue conditioning

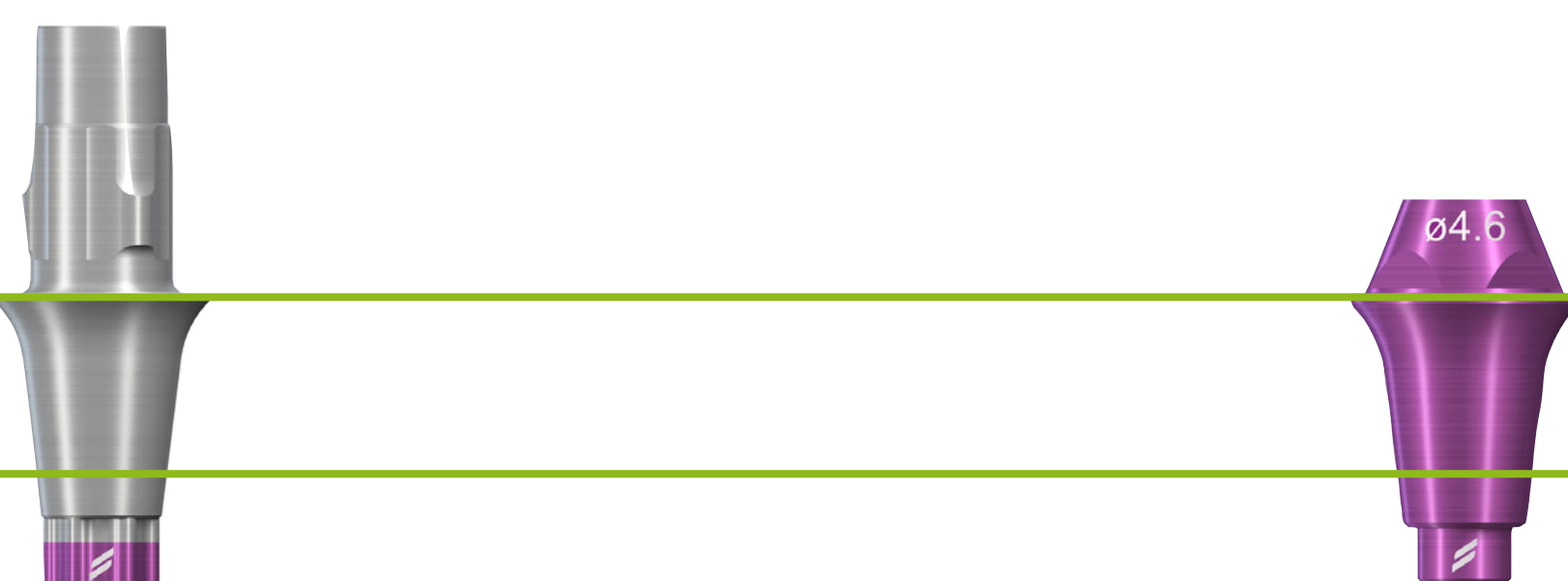
Crowns	Healing Abutments for Crown*	Temporary Abutments for Crown	Final Abutments
<p>Gingiva Height 1.5 mm</p> 	 <p>064.4212S / 064.4213S</p>	 <p>064.4372</p>	 <p>062.4944 062.4972 062.4982 062.4722S 062.4420</p> <p>1.5 mm</p>
<p>Final Abutment Ø4.5 mm</p> <p>Gingiva Height 2.5 mm</p> 	 <p>064.4214S / 064.4215S</p>	 <p>064.4373</p>	 <p>062.4945 062.4723S</p> <p>2.5 mm</p>
<p>Gingiva Height 3.5 mm</p> 	 <p>064.4216S / 064.4217S</p>	 <p>064.4374</p>	 <p>062.4946 062.4724S</p> <p>3.5 mm</p>

Note: For bridge reconstructions use dedicated Healing Abutments and Temporary Abutments to ensure appropriate protection of the implant shoulder during the healing phase.

Straumann® Modular Cassette

A compact and customizable instrument cassette for all Straumann® Implant lines

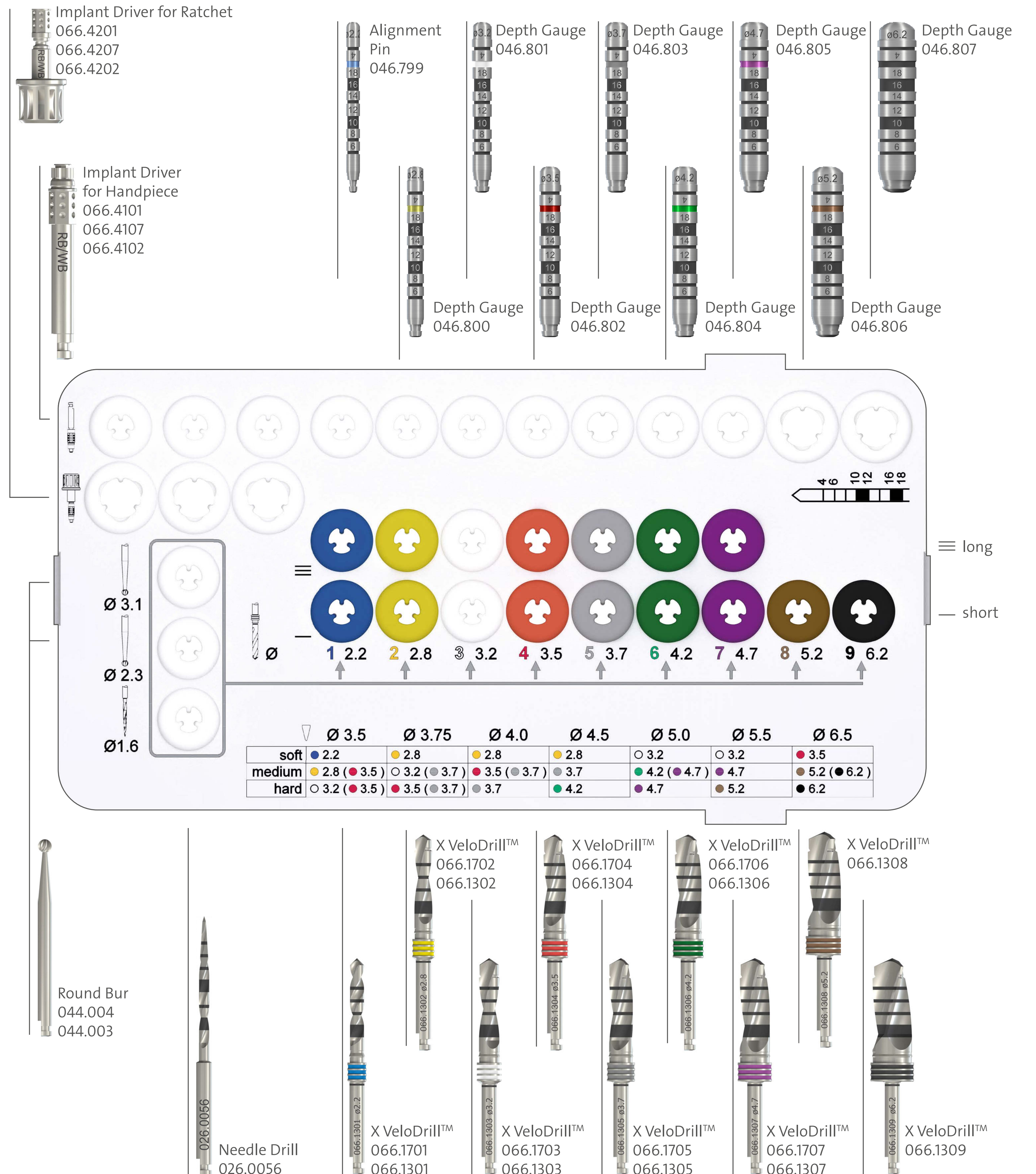

Guided Surgery components

The Straumann® VeloDrill™ System can be used for freehand and guided surgery and minimize the heat generation during drilling

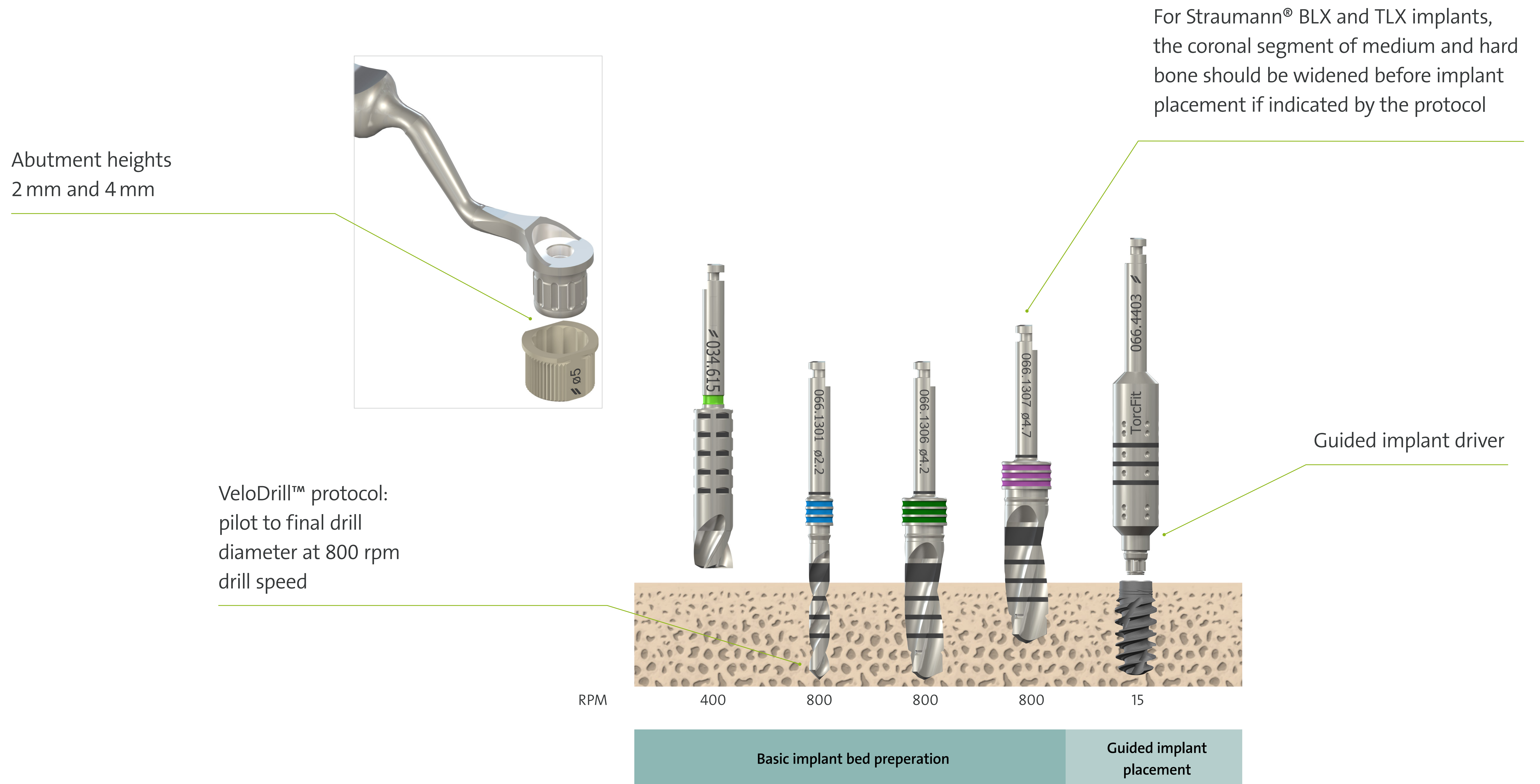

BLX Guided Surgery protocol

Fully guided workflow for BLX \varnothing 3.5 mm – \varnothing 4.5 mm

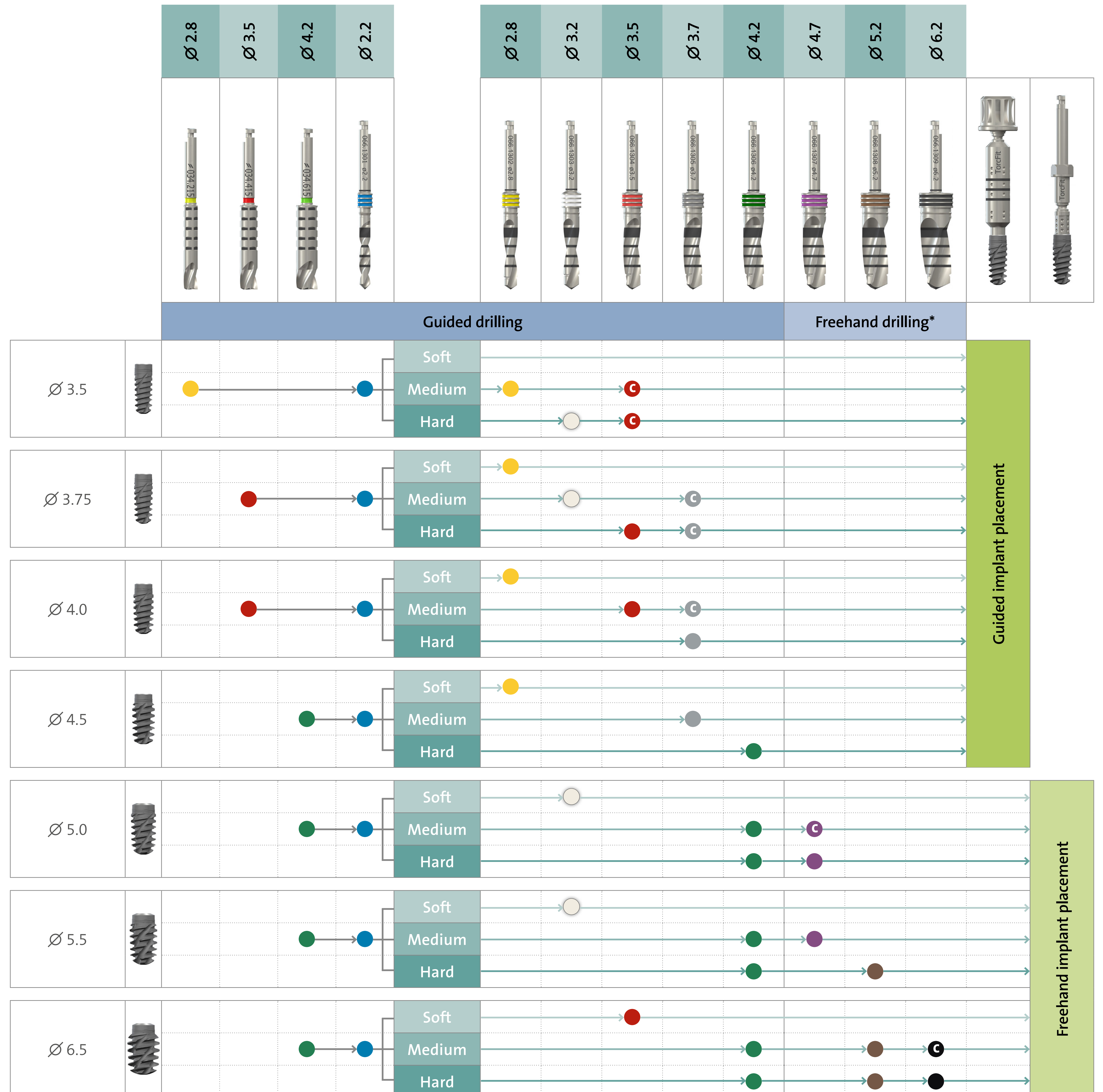

- Recommended – full depth
- Recommended – cortical only
 - do a depth of 4 mm for implants with a length of 6 mm and 8 mm
 - do a depth of 6 mm for implants with a length of 10 mm to 18 mm

*Note: Guided handles are compatible up to \varnothing 4.2 mm. For drills larger than \varnothing 4.2 mm remove the template for freehand drilling.

Straumann® BLX Implant System



490.673/en/A/00 02/21

International Headquarters

Institut Straumann AG
Peter Merian-Weg 12
CH-4002 Basel, Switzerland
Phone +41 (0)61 965 11 11
Fax +41 (0)61 965 11 01
www.straumann.com

© Institut Straumann AG, 2021. All rights reserved.

Straumann® and/or other trademarks and logos from Straumann® mentioned herein are the trademarks or registered trademarks of Straumann Holding AG and/or its affiliates.

