

Straumann® BLX Implant System





INTERNATIONAL EDITION

Product Catalog 2022/2023

List of abbreviations

ABS	Acrylonitrile butadiene styrene
ADLC	Amorphous diamond-like carbon
Al	Aluminum
AS	Angled Solution
BL	Bone Level
BLT	Bone Level Tapered
CI	Ceramic Implant
CIM	Ceramic Implant Monotype
EDTA	Ethylenediaminetetraacetic acid
EMD	Enamel matrix derivative
HT	High Translucent
LDPE	Low-density polyethylene
LT	Low Translucent
MI	Mini Implant
MO 0	Medium Opacity 0
MO 1	Medium Opacity 1
NC	Narrow CrossFit® = implant diameter 3.3 mm, BL and BLT implants
Ncm	Newton centimeter, measurement for torque
ND	Narrow Diameter = implant shoulder diameter 3.5 mm, Straumann® PURE Ceramic Implants
NN	Narrow Neck = implant shoulder diameter 3.5 mm, SP implants
NNC	Narrow Neck CrossFit® = implant diameter 3.3 mm, implant shoulder diameter 3.5 mm, SP implants
PA	Polyamide
PC	Polycarbonate
PEEK	Polyetheretherketone
PMMA	Polymethylmethacrylate
POM	Polyoxymethylene
PPS	Polyphenylene sulfide
PS	Polystyrene
PSU	Polysulfone
RC	Regular CrossFit® = implant diameter 4.1 and 4.8 mm, BL and BLT implants
RD	Regular Diameter = implant shoulder diameter 4.8 mm, Straumann® PURE Ceramic Implants
RN	Regular Neck = implant shoulder diameter 4.8 mm, S/SP/TE implants
S	Standard
SC	Small CrossFit® = implant diameter 2.9 mm, BLT implants
SCS	Screw Carrying System
SP	Standard Plus
TAN	Titanium-aluminum-niobium alloy
TAV	Titanium-aluminum-vanadium alloy
TE	Tapered Effect
Ti	Titanium
Ti-N	Titanium nitride
TiZr	Titanium-zirconium alloy (Roxolid®)
TS	Transversal screw retention
WN	Wide Neck = implant shoulder diameter 6.5 mm, S/SP/TE implants
xxx.xxx-04	Pack of 4
xxx.xxxV2	Pack of 2
xxx.xxxV4	Pack of 4
xxx.xxxV5	Pack of 5
xxx.xxxV10	Pack of 10
xxx.xxxV20	Pack of 20
ZrO2	Zirconium dioxide

Table of Contents

	<p>Surgery 5</p> <p>BLX Implants 6</p>	Surgery
	<p>Prosthetics 11</p> <p>BLX Prosthetics 12</p>	Prosthetics
	<p>Instruments and Accessories 35</p> <p>Surgery 36</p> <p>Prosthetics 44</p>	Instruments and Accessories
	<p>Information and Index 49</p> <p>Index 50</p>	Information and Index

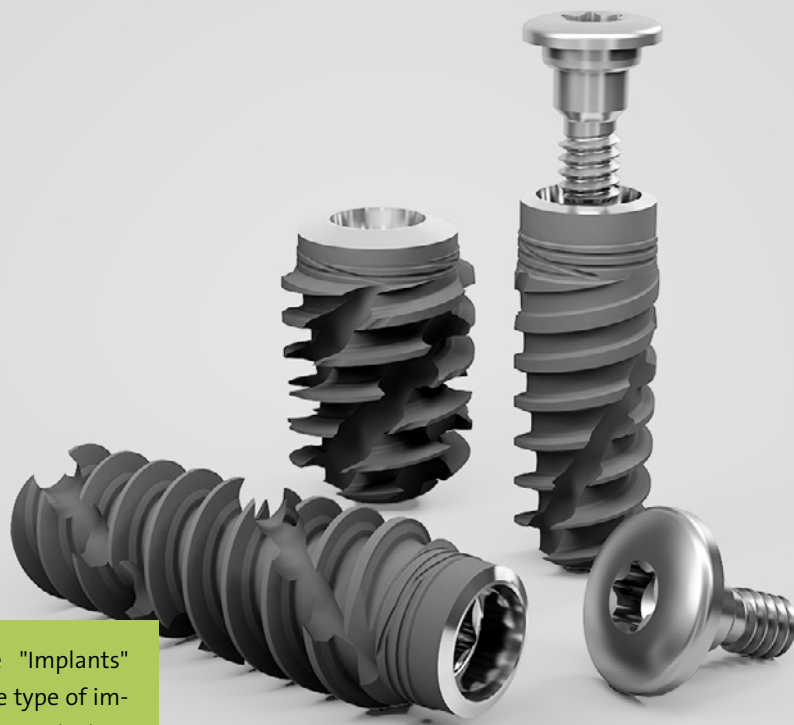

When searching the "Implants" chapter, first select the type of implant – BLX Regular Base (RB) or BLX Wide Base (WB). Then specify the desired implant diameter. These are marked by colored rectangles on the side tabs of each page. Instruments and accessories can be found in the corresponding chapter.

Straumann® BLX: Confidence beyond Immediacy

The Straumann® BLX Implant System is the next generation solution for confidence beyond immediacy.

Straumann® BLX has been designed for immediacy, and is also suitable for all other treatment protocols – ranging from immediate to conventional placement and loading – to suit the dentist's preference. The intelligent implant concept allows for Straumann Dynamic Bone Management and is designed for immediate protocols in all bone types. With a simplified but versatile portfolio, featuring one connection and under-contoured prosthetics to deliver esthetics with ease.

Straumann® BLX, the winning combination of innovative design and surface technology with high-performance material designed for predictable results you can trust.

Surgery

BLX Implants	6
Regular Base (RB)	6
Implants	6
Implants and Closure Caps	7
Wide Base (WB)	8
Implants	8
Implants and Closure Caps	9

Roxolid® SLActive®

Surgery

Product	Platform	Image	Material	Length	Art.-No.
Straumann® BLX Implant Ø 3.5 mm	RB – Regular Base Ø 3.5 mm		Roxolid®	8 mm	061.3308
				10 mm	061.3310
				12 mm	061.3312
				14 mm	061.3314
				16 mm	061.3316
				18 mm	061.3318
Straumann® BLX Implant Ø 3.75 mm	RB – Regular Base Ø 3.75 mm		Roxolid®	6 mm	061.4306
				8 mm	061.4308
				10 mm	061.4310
				12 mm	061.4312
				14 mm	061.4314
				16 mm	061.4316
Straumann® BLX Implant Ø 4.0 mm	RB – Regular Base Ø 4.0 mm		Roxolid®	18 mm	061.4318
				6 mm	061.5306
				8 mm	061.5308
				10 mm	061.5310
				12 mm	061.5312
				14 mm	061.5314
Straumann® BLX Implant Ø 4.5 mm	RB – Regular Base Ø 4.5 mm		Roxolid®	16 mm	061.5316
				18 mm	061.5318
				6 mm	061.6306
				8 mm	061.6308
				10 mm	061.6310
				12 mm	061.6312
				14 mm	061.6314
				16 mm	061.6316
				18 mm	061.6318



Roxolid® SLA®

Product	Platform	Image	Material	Length	Art.-No.
Straumann® BLX Implant Ø 3.5 mm	RB – Regular Base Ø 3.5 mm		Roxolid®	8 mm	061.3508
				10 mm	061.3510
				12 mm	061.3512
				14 mm	061.3514
				16 mm	061.3516
				18 mm	061.3518
Straumann® BLX Implant Ø 3.75 mm	RB – Regular Base Ø 3.75 mm		Roxolid®	6 mm	061.4506
				8 mm	061.4508
				10 mm	061.4510
				12 mm	061.4512
				14 mm	061.4514
				16 mm	061.4516
Straumann® BLX Implant Ø 4.0 mm	RB – Regular Base Ø 4.0 mm		Roxolid®	18 mm	061.4518
				6 mm	061.5506
				8 mm	061.5508
				10 mm	061.5510
				12 mm	061.5512
				14 mm	061.5514
Straumann® BLX Implant Ø 4.5 mm	RB – Regular Base Ø 4.5 mm		Roxolid®	16 mm	061.5516
				18 mm	061.5518
				6 mm	061.6506
				8 mm	061.6508
				10 mm	061.6510
				12 mm	061.6512
				14 mm	061.6514
				16 mm	061.6516
				18 mm	061.6518

Surgery

RB Closure Cap

Product	Image	Description	Height	Material	Art.-No.
Closure Caps					
RB Closure Cap			0,4 mm	Ti	064.4100S

Roxolid® SLActive®

Surgery

Product	Platform	Image	Material	Length	Art.-No.
Straumann® BLX Implant Ø 5.0 mm	WB – Wide Base Ø 5.0 mm		Roxolid®	6 mm	061.7306
				8 mm	061.7308
				10 mm	061.7310
				12 mm	061.7312
				14 mm	061.7314
				16 mm	061.7316
				18 mm	061.7318
Straumann® BLX Implant Ø 5.5 mm	WB – Wide Base Ø 5.5 mm		Roxolid®	6 mm	061.8306
				8 mm	061.8308
				10 mm	061.8310
				12 mm	061.8312
				14 mm	061.8314
				16 mm	061.8316
Straumann® BLX Implant Ø 6.5 mm	WB – Wide Base Ø 6.5 mm		Roxolid®	6 mm	061.9306
				8 mm	061.9308
				10 mm	061.9310
				12 mm	061.9312
				14 mm	061.9314
				16 mm	061.9316





Roxidid® SLA®

Product	Platform	Image	Material	Length	Art.-No.
Straumann® BLX Implant Ø 5.0 mm	WB – Wide Base Ø 5.0 mm		Roxidid®	6 mm	061.7506
				8 mm	061.7508
				10 mm	061.7510
				12 mm	061.7512
				14 mm	061.7514
				16 mm	061.7516
				18 mm	061.7518
Straumann® BLX Implant Ø 5.5 mm	WB – Wide Base Ø 5.5 mm		Roxidid®	6 mm	061.8506
				8 mm	061.8508
				10 mm	061.8510
				12 mm	061.8512
				14 mm	061.8514
				16 mm	061.8516
Straumann® BLX Implant Ø 6.5 mm	WB – Wide Base Ø 6.5 mm		Roxidid®	6 mm	061.9506
				8 mm	061.9508
				10 mm	061.9510
				12 mm	061.9512
				14 mm	061.9514
				16 mm	061.9516

Surgery

WB Closure Cap

Product	Image	Description	Height	Material	Art.-No.
Closure Caps					
WB Closure Cap			0,5 mm	Ti	064.81025



When searching for prosthetic components, first specify between Regular Base (RB) and Wide Base (WB) implants. RB/WB abutments fit both RB and WB implants. WB abutments only fit WB implants. In this section, you will find prosthetics components, ranging from single crown to hybrid restoration. Instruments and accessories can be found in the "Instruments and Accessories" chapter.

More than just highest precision: a perfectly adjusted system

Straumann offers a wide variety of **implant-borne prosthetic solutions** for all indications – ranging from single tooth restorations to edentulous solutions. Our high-quality connection solutions, Straumann® TorcFit™, ensure **safe positioning** of the abutment on the implant and therefore **long-lasting stability**. A broad range of materials combined with a choice of screw-retained, cemented and hybrid restorations complete our portfolio.

Original on original

Straumann knows all dimensions, tolerances and materials of all Straumann implants. With this knowledge we tune the design of implants and prosthetic components perfectly to each other. High precision in manufacturing and thorough testing processes ensure the consistent quality of all original Straumann components.

Straumann® CARES® for individual CAD/CAM prosthetics



Straumann® CARES® offers you prosthetic solutions from single tooth restorations to tooth-borne dental bridges, all the way to implant-borne restorations. This is complemented by a comprehensive choice of materials and simple processes. This means precision, a high degree of efficiency and highly aesthetic results in every single product.





Prosthetics

BLX Prosthetics	12
RB/WB Prosthetic	12
Impression-taking/Master Cast Fabrication	12
Healing Abutments	13
Crowns and Bridges	15
Hybrid	26
WB Prosthetic	29
Impression-taking/Master Cast Fabrication	29
Healing Abutments	30
Crowns and Bridges	31

Impression Posts

Product	Image	Description	Material	Art.-No.
Impression Posts and Analog				
RB Impression Post Open Tray		short, with guide screw, length 16.5 mm	TAN	065.0031
		long, with guide screw, length 24 mm		065.0033
RB Impression Post Closed Tray		with guide screw, length 13 mm		065.4310













Digital Impression

Product	Image	Description	Material	Art.-No.
Digital Impression				
RB/WB CARES® Mono Scanbody		Ø 3.8 mm, height 10 mm	PEEK/TAN	065.0035
RB Repositionable Implant Analog		for fully digital workflow, length 17 mm	Stainless steel	065.0023
ScanPost S RB/WB L		for Dentsply® Sirona®, size L	TAN	065.0038

Analogs

Product	Image	Description	Material	Art.-No.
Analogs				
RB Implant Analog		length 12 mm	TAN	065.0021

Healing Abutments

Product	Image	Description	Material	Art.-No.
Healing Abutments, Crown				
RB/WB Healing Abutment, for final abutments Ø 3.8 mm		Crown, Ø 4 mm, gingiva height 1.5 mm, abutment height 2 mm, (total 3.5 mm)	Ti	064.4202S
		Crown, Ø 4 mm, gingiva height 1.5 mm, abutment height 4 mm, (total 5.5 mm)		064.4203S
		Crown, Ø 4 mm, gingiva height 2.5 mm, abutment height 2 mm, (total 4.5 mm)		064.4204S
		Crown, Ø 4 mm, gingiva height 2.5 mm, abutment height 4 mm, (total 6.5 mm)		064.4205S
		Crown, Ø 4 mm, gingiva height 3.5 mm, abutment height 2 mm, (total 5.5 mm)		064.4206S
		Crown, Ø 4 mm, gingiva height 3.5 mm, abutment height 4 mm, (total 7.5 mm)		064.4207S
RB/WB Healing Abutment, for final abutments Ø 4.5 mm		Crown, Ø 5 mm, gingiva height 1.5 mm, abutment height 2 mm, (total 3.5 mm)	064.4212S	
		Crown, Ø 5 mm, gingiva height 1.5 mm, abutment height 4 mm, (total 5.5 mm)	064.4213S	
		Crown, Ø 5 mm, gingiva height 2.5 mm, abutment height 2 mm, (total 4.5 mm)	064.4214S	
		Crown, Ø 5 mm, gingiva height 2.5 mm, abutment height 4 mm, (total 6.5 mm)	064.4215S	
		Crown, Ø 5 mm, gingiva height 3.5 mm, abutment height 2 mm, (total 5.5 mm)	064.4216S	
		Crown, Ø 5 mm, gingiva height 3.5 mm, abutment height 4 mm, (total 7.5 mm)	064.4217S	

Prosthetics

Healing Abutment Dimensions

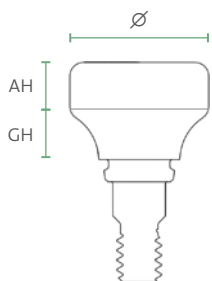

AH = abutment height
 GH = gingiva height
 Ø = diameter

Healing Abutments

Product	Image	Description	Material	Art.-No.
RB/WB Healing Abutment, for final abutments Ø 6.0 mm		Crown, Ø 6.5 mm, gingiva height 1.5 mm, abutment height 2 mm, (total 3.5 mm)	Ti	064.4222S
		Crown, Ø 6.5 mm, gingiva height 1.5 mm, abutment height 4 mm, (total 5.5 mm)		064.4223S
		Crown, Ø 6.5 mm, gingiva height 2.5 mm, abutment height 2 mm, (total 4.5 mm)		064.4224S
		Crown, Ø 6.5 mm, gingiva height 2.5 mm, abutment height 4 mm, (total 6.5 mm)		064.4225S
		Crown, Ø 6.5 mm, gingiva height 3.5 mm, abutment height 2 mm, (total 5.5 mm)		064.4226S
		Crown, Ø 6.5 mm, gingiva height 3.5 mm, abutment height 4 mm, (total 7.5 mm)		064.4227S
		Crown, Ø 7.5 mm, gingiva height 2.5 mm, abutment height 2 mm, (total 4.5 mm)		064.4234S
		Crown, Ø 7.5 mm, gingiva height 2.5 mm, abutment height 4 mm, (total 6.5 mm)		064.4235S
		Crown, Ø 7.5 mm, gingiva height 3.5 mm, abutment height 2 mm, (total 5.5 mm)		064.4236S
		Crown, Ø 7.5 mm, gingiva height 3.5 mm, abutment height 4 mm, (total 7.5 mm)		064.4237S
Healing Abutments, Bridge				
RB/WB Healing Abutment, for final abutments Ø 4.5 mm		Bridge/Bar, Ø 5 mm, gingiva height 1.5 mm, abutment height 2 mm, (total 3.5 mm)	Ti	064.4232S
		Bridge/Bar, Ø 5 mm, gingiva height 1.5 mm, abutment height 4 mm, (total 5.5 mm)		064.4233S

Always communicate the selected healing abutment to the dental lab

The BLX Healing Abutment selection determines the available options for the final restoration. Therefore, always communicate the implant diameter and the selected healing abutment to the restoring dentist or dental lab in order to facilitate the appropriate final abutment selection.

For more information refer to *Straumann® BLX Implant System – Healing Abutment selection, Quick Guide (704658/en)*.

Straumann® BLX Implant System – Healing Abutment selection Quick Guide

The total height of a BLX Healing Abutment consists of two parts:

- Gingiva Height (GH):** Emerging part of the healing abutment, available in heights of 0.25mm to 3.5mm. Uniform profile throughout the BLX prosthetic portfolio.
- Abutment Height (AH):** Cylindrical part of the healing abutment, available in two heights: 2mm (fixed) or 4mm (high).

Always communicate the implant diameter and the selected healing abutment to the dental lab!

Please consider, that the BLX Healing Abutment selection determines the available options for the final restoration.



















Slim profile single crown	Wide profile single crown, molar	Bridge
<p>RB/WB Healing Abutment Ø 4.0/5.0/6.0/7.5 mm 1.5mm GH: 2.2mm 3.5mm</p> <p>After healing, no wide profile crown (WB) or bridge restoration possible, see on the back page. Note: Use Healing Abutment Ø 5.0, GH 1.5 mm for Variobase® AS and RB/WB A&B® Abutments.</p>	<p>WB Healing Abutment Ø 4.0/7.5 mm 1.5mm GH: 0.75 mm 1.5mm</p> <p>Note: For WB BLX implants.</p>	<p>RB/WB Healing Abutment for Bridge/Bar Ø 5.0 mm GH: 1.5mm</p> <p>Note: Use this healing abutment if it has not yet been determined whether the restoration will consist of single crowns or a bridge.</p>

For more information refer to the *Straumann® BLX Implant System Connected Emergence Profile™* and *Healing Abutment selection (704658/en)*.

straumann







Temporary Restorations





Product	Image	Description	Material	Art.-No.
VITA CAD-Temp®				
RB/WB Temporary Abutment		Ø 3.8 mm, gingiva height 1.5 mm	PMMA/TAN	064.4361
		Ø 4.5 mm, gingiva height 1.5 mm		064.4371
Temporary Abutments				
RB/WB Temporary Abutment		for crowns, Ø 3.8 mm, gingiva height 1.5 mm	TAN	064.4362
		for crowns, Ø 3.8 mm, gingiva height 2.5 mm		064.4363
		for crowns, Ø 3.8 mm, gingiva height 3.5 mm		064.4364
		for crowns, Ø 4.5 mm, gingiva height 1.5 mm		064.4372
		for crowns, Ø 4.5 mm, gingiva height 2.5 mm		064.4373
		for crowns, Ø 4.5 mm, gingiva height 3.5 mm		064.4374
		for crowns, Ø 6 mm, gingiva height 2.5 mm		064.4382
		for crowns, Ø 6 mm, gingiva height 3.5 mm		064.4383
RB/WB Temporary Abutment for Bridge/Bar *		for bridges, Ø 4.5 mm, gingiva height 1.5 mm, abutment height 10 mm		064.4352
Immediate Temporary Abutments				
RB/WB Immediate Temporary Abutment		for crowns, Ø 3.8 mm, gingiva height 1.5 mm, sterile	TAN	064.4322S
		for crowns, Ø 3.8 mm, gingiva height 2.5 mm, sterile		064.4323S
		for crowns, Ø 3.8 mm, gingiva height 3.5 mm, sterile		064.4324S
		for crowns, Ø 4.5 mm, gingiva height 1.5 mm, sterile		064.4332S
		for crowns, Ø 4.5 mm, gingiva height 2.5 mm, sterile		064.4333S
		for crowns, Ø 4.5 mm, gingiva height 3.5 mm, sterile		064.4334S
Plastic Coping		for Immediate Temporary Abutment, packaging 2 pieces	PMMA	023.0033V2
Replacement Screw				
RB/WB Basal Screw		for RB/WB Temporary Abutments, Anatomic Abutments, Variobase® for Crown, Variobase® for Bridge/Bar Cylindrical, angled Screw-retained Abutments, Pre-milled Abutment Blanks, Gold Abutments, and angled Novaloc® Abutments, length 6.1 mm	TAN	065.0036

* Dedicated healing abutments are available for Bridge/Bar restorations.

Cement-Retained Restoration, Anatomic Abutments

Product	Image	Description	Material	Art.-No.
Anatomic Abutments, Titanium				
RB/WB Anatomic Abutment		straight, gingiva height 2.5 mm	TAN	062.4103
		straight, gingiva height 3.5 mm		062.4104
		angled, angulation 17°, gingiva height 2.5 mm		062.4153
		angled, angulation 17°, gingiva height 3.5 mm		062.4154
Replacement Screw				
RB/WB Basal Screw		for RB/WB Temporary Abutments, Anatomic Abutments, Variobase® for Crown, Variobase® for Bridge/Bar Cylindrical, angled Screw-retained Abutments, Pre-milled Abutment Blanks, Gold Abutments, and angled Novaloc® Abutments, length 6.1 mm	TAN	065.0036

Cement or Screw-retained Restoration, Gold Abutments

Product	Image	Description	Material	Art.-No.
Gold Abutment				
RB/WB Gold Abutment		for crowns, including screw 065.0036, gingiva height 1.5 mm, Ø 3.8 mm	Ceramicor®/ POM	062.4410
		for crowns, including screw 065.0036, gingiva height 1.5 mm, Ø 4.5 mm		062.4420
RB/WB Gold Abutment for Bridge/Bar *		for bridges, including screw 065.0036, gingiva height 1.5 mm, Ø 4.5 mm		062.4430
Replacement Screw				
RB/WB Basal Screw		for RB/WB Temporary Abutments, Anatomic Abutments, Variobase® for Crown, Variobase® for Bridge/Bar Cylindrical, angled Screw-retained Abutments, Pre-milled Abutment Blanks, Gold Abutments, and angled Novaloc® Abutments, length 6.1 mm	TAN	065.0036

* Dedicated healing abutments and temporary abutments are available for Bridge/Bar restorations.

Ceramicor® is a non-oxidizing precious metal alloy for casting on precious metal alloys.



Cement or Screw-retained Restoration, CAD/CAM

Product	Image	Description	Material	Art.-No.
Replacement Screws				
RB/WB Basal Screw		for RB/WB Temporary Abutments, Anatomic Abutments, Variobase® for Crown, Variobase® for Bridge/Bar Cylindrical, angled Screw-retained Abutments, Pre-milled Abutment Blanks, Gold Abutments, and angled Novaloc® Abutments, length 6.1 mm	TAN	065.0036
RB/WB Basal Screw AS		for RB/WB Variobase® Crown AS, length 6.5 mm, only compatible with AS Screwdriver (green color-coding)		065.0037
Occlusal Screw		for Titanium, Gold, Burn-Out and Variobase® Copings for Screw-retained Abutments, length 3.7 mm		023.4763

Straumann® CARES® CAD/CAM

- Customized solutions ranging from individual tooth restorations to tooth-borne bridges to implant-borne restorations
- Wide range of applications and choice of materials
- Access to premium customized genuine Straumann® CARES® abutments through Straumann® CARES® Scan & Shape, without additional hardware and software investments
- Customized solutions for all indications
- Additional information at www.straumann.com

Cement or Screw-retained Restoration, Variobase®

Product	Image	Description	Material	Art.-No.
Variobase® Abutments				
RB/WB Variobase® for Crown		including screw, Ø 3.8 mm, gingiva height 1.5 mm, abutment height 5.5 mm	TAN	062.4934
		including screw, Ø 3.8 mm, gingiva height 2.5 mm, abutment height 5.5 mm		062.4935
		including screw, Ø 3.8 mm, gingiva height 3.5 mm, abutment height 5.5 mm		062.4936
		including screw, Ø 4.5 mm, gingiva height 1.5 mm, abutment height 5.5 mm		062.4944
		including screw, Ø 4.5 mm, gingiva height 2.5 mm, abutment height 5.5 mm		062.4945
		including screw, Ø 4.5 mm, gingiva height 3.5 mm, abutment height 5.5 mm		062.4946
RB/WB Variobase® C		for Dentsply® Sirona®, including screw 065.0036, Ø 3.8 mm, gingiva height 1.5 mm		062.4981
		for Dentsply® Sirona®, including screw 065.0036, Ø 4.5 mm, gingiva height 1.5 mm		062.4982
RB/WB Variobase® for Bridge/Bar Cylindrical *		including screw and Cementation Aid 3, Ø 4.5 mm, gingiva height 1.5 mm, abutment height 3.5 mm		062.4961
RB/WB Variobase® for Crown AS		including screw, Ø 4.5 mm, gingiva height 1.5 mm, abutment height 5.5 mm		062.4972
Burn-out Copings				
RB/WB Burn-out Coping		for Variobase® for Crown, Ø 3.8 mm, abutment height 5.5 mm	POM	065.0014
		for Variobase® for Crown, Ø 4.5 mm, abutment height 5.5 mm		065.0015
RB/WB Burn-out Coping for Bridge/Bar		for Variobase® for Bridge/Bar, Ø 4.5 mm, abutment height 3.5 mm		065.0017
		for Variobase® for Bridge/Bar, Ø 4.5 mm, abutment height 3.5 mm, packaging 4 pieces		065.0017V4
Burn-out Copings AS				
RB/WB Burn-out Coping		angulation 25°, for Variobase® for Crown AS, Ø 4.5 mm, abutment height 5.5 mm	POM	065.0018
Replacement Screw				
RB/WB Basal Screw		for RB/WB Temporary Abutments, Anatomic Abutments, Variobase® for Crown, Variobase® for Bridge/Bar Cylindrical, angled Screw-retained Abutments, Pre-milled Abutment Blanks, Gold Abutments, and angled Novaloc® Abutments, length 6.1 mm	TAN	065.0036
RB/WB Basal Screw AS		for RB/WB Variobase® Crown AS, length 6.5 mm, only compatible with AS Screwdriver (green color-coding)		065.0037

* Dedicated healing abutments are available for Bridge/Bar restorations.



Screw-retained Restoration with Screw-retained Abutment, Abutments, sterile

Product	Image	Description	Material	Art.-No.
Screw-retained Abutments 0°, sterile				
RB/WB Screw-retained Abutment		straight, angulation 0°, Ø 4.6 mm, gingiva height 1.5 mm, sterile	TAN	062.4722S
		straight, angulation 0°, Ø 4.6 mm, gingiva height 2.5 mm, sterile		062.4723S
		straight, angulation 0°, Ø 4.6 mm, gingiva height 3.5 mm, sterile		062.4724S
		straight, angulation 0°, Ø 4.6 mm, gingiva height 4.5 mm, sterile		062.4725S
Screw-retained Abutments 17°, sterile				
RB/WB Screw-retained Abutment		angled, angulation 17°, Ø 4.6 mm, gingiva height 3.5 mm, sterile	TAN	062.4733S
		angled, angulation 17°, Ø 4.6 mm, gingiva height 4.5 mm, sterile		062.4734S
		angled, angulation 17°, Ø 4.6 mm, gingiva height 5.5 mm, sterile		062.4735S
Screw-retained Abutments 30°, sterile				
RB/WB Screw-retained Abutment		angled, angulation 30°, Ø 4.6 mm, gingiva height 3.5 mm, sterile	TAN	062.4743S
		angled, angulation 30°, Ø 4.6 mm, gingiva height 4.5 mm, sterile		062.4744S
		angled, angulation 30°, Ø 4.6 mm, gingiva height 5.5 mm, sterile		062.4745S
Replacement Screws				
RB/WB Basal Screw		for RB/WB Temporary Abutments, Anatomic Abutments, Variobase® for Crown, Variobase® for Bridge/Bar Cylindrical, angled Screw-retained Abutments, Pre-milled Abutment Blanks, Gold Abutments, and angled Novaloc® Abutments, length 6.1 mm	TAN	065.0036
Occlusal Screw		for Titanium, Gold, Burn-Out and Variobase® Copings for Screw-retained Abutments, length 3.7 mm		023.4763
Plan Abutment for Screw-retained Abutments				
RB/WB Plan Abutment		for Screw-retained Abutments, angulation 0°, gingiva height 1.5/2.5/3.5/4.5 mm	POM	025.0073V4
		for Screw-retained Abutments, angulation 17°, gingiva height 3.5/4.5/5.5 mm		025.0074V4
		for Screw-retained Abutments, angulation 30°, gingiva height 3.5/4.5/5.5 mm		025.0075V4

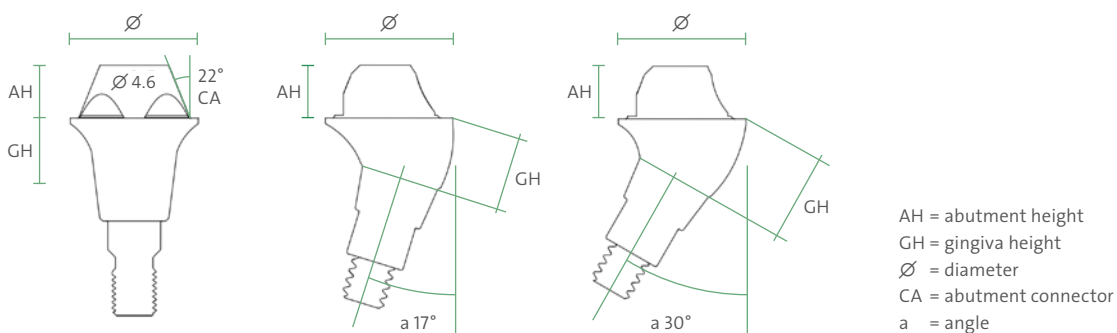

Screw-retained Abutment Dimensions



Screw-retained Restoration with Screw-retained Abutment

Product	Image	Description	Material	Art.-No.
Impression Posts (at abutment level) for Single Crown Restoration (engaging)				
Impression Posts for Open-tray Impression		for Screw-retained Abutments, abutment level, Ø 4.6 mm	TAN	025.2244
Impression Posts for Closed-tray Impression			TAN/POM	025.2246
Impression Posts (at abutment level) for Multi-Unit Restorations (non engaging)				
Impression Posts for Open-tray Impression		for Screw-retained Abutments, abutment level, Ø 4.6 mm	TAN	025.0012
Impression Posts for Closed-tray Impression			TAN/POM	025.0014
Digital Impression				
CARES® Mono Scanbody		for Screw-retained Abutments, abutment level, including Fixation Screw, Ø 4.6 mm	PEEK	025.0001
Repositionable Analog		for Screw-retained Abutments, Ø 4.6 mm	Stainless steel	025.0008
Analogs				
Analog for Screw-retained Abutments Ø 4.6 mm		for Screw-retained Abutments Ø 4.6 mm, straight	TAN	023.4756
		for Screw-retained Abutments Ø 4.6 mm, edentulous, straight		025.0050
		for Screw-retained Abutments Ø 4.6 mm, angled, angulation 17°/30°		023.4757
Lab Auxiliaries				
Polishing Aid		for Screw-retained Abutments, Ø 4.6 mm	TAN	025.0005
		packaging 4 pieces		025.0005V4
Lab Processing Screw		for Screw-retained Abutments, length 20 mm	Stainless steel	025.0006
		for Screw-retained Abutments, length 10 mm		025.0052
Protective Caps				
Protective Cap for Screw-retained Abutments Ø 4.6 mm		for Screw-retained Abutments Ø 4.6 mm, including screw 023.4763, height 5.1 mm, Ø 5.0 mm, packaging 4 pieces	PEEK/TAN	024.4323-04
		for Screw-retained Abutments Ø 4.6 mm, including screw 023.4763, height 6.6 mm, Ø 5.0 mm, packaging 4 pieces		024.4324-04
		for Screw-retained Abutments Ø 4.6 mm, including screw 023.4763, height 8.1 mm, Ø 5.0 mm, packaging 4 pieces		024.4325-04
		for Screw-retained Abutments Ø 4.6 mm, including screw 023.4763, height 4.5 mm, wide, packaging 4 pieces		024.0020-04

Screw-retained Restoration with Screw-retained Abutment



Product	Image	Description	Material	Art.-No.
Auxiliary Parts				
Straumann® Planning Guide		visual guide for tilted implant placement in Straumann® Pro Arch cases	TAV/Ti	026.0016
Transfer And Alignment Pin		for Screw-retained Abutments	TAN	025.0009
Hexagonal Screwdriver		for Straumann® Planning Guide, length 30 mm	Stainless steel	046.421

Screw-retained Restoration with Screw-retained Abutment, Copings



Product	Image	Description	Material	Art.-No.
Variobase® Copings				
Variobase® for Bridge/Bar Cylindrical Coping for Screw-retained Abutments Ø 4.6 mm		for Screw-retained Abutments Ø 4.6 mm, including screw 023.4763 and Cementation Aid 3, Ø 5.1 mm, height 4 mm	TAN	023.0028
Burn-out Coping		for Variobase® for Bridge/Bar Cylindrical, Coping Screw-retained Abutment Ø 4.6 mm, Ø 5.1 mm, height 11.1 mm	POM	023.0032
		packaging 4 pieces		023.0032V4
Titanium Copings				
Coping for Screw-retained Abutments Ø 4.6 mm		for Screw-retained Abutments Ø 4.6 mm, for crowns, including screw 023.4763, height 11 mm	Ti	023.4747
		for Screw-retained Abutments Ø 4.6 mm, for bridges, including screw 023.4763, height 11 mm		023.4751
Temporary Coping for Screw-retained Abutments Ø 4.6 mm		for Screw-retained Abutments Ø 4.6 mm, for crowns, including screw 023.4763, height 11.5 mm	TAN	024.0023
		for Screw-retained Abutments Ø 4.6 mm, for bridges, including screw 023.4763, height 11.5 mm		024.0024
Gold Copings				
Coping for Screw-retained Abutments		for Screw-retained Abutments Ø 4.6 mm, for crowns, including screw 023.4763, alloy weight 0.440 g	Ceramicor®/ POM	023.4753
		for Screw-retained Abutments Ø 4.6 mm, for bridges, including screw 023.4763, alloy weight 0.469 g		023.4754
Burn-out Copings				
Burn-out Coping for Screw-retained Abutments		for Screw-retained Abutments Ø 4.6 mm, for crowns, including screw 023.4763, height 11 mm	POM	023.4748
		for Screw-retained Abutments Ø 4.6 mm, for bridges and bars, including screw 023.4763, height 11 mm		023.4758
Replacement Screw				
Occlusal Screw		for Titanium, Gold, Burn-Out and Variobase® Copings for Screw-retained Abutments, length 3.7 mm	TAN	023.4763

Ceramicor® is a non-oxidizing precious metal alloy for casting on precious metal alloys.



Bar Construction on Screw-retained Abutments, Gold

Product	Image	Description	Material	Art.-No.
Bar Gold Coping Ø 4.6 mm				
Coping for Screw-retained Abutments		for Screw-retained Abutments Ø 4.6 mm, for bars, including screw 023.4763, alloy weight 0.744 g, height 5.5 mm	Ceramicor®	023.4755
Replacement Screw				
Occlusal Screw		for Titanium, Gold, Burn-Out and Variobase® Copings for Screw-retained Abutments, length 3.7 mm	TAN	023.4763





Bar Construction on Screw-retained Abutments, Titanium

Product	Image	Description	Material	Art.-No.
Bar Titanium Coping Ø 4.6 mm				
Coping for Screw-retained Abutments		for Screw-retained Abutments Ø 4.6 mm, including screw 023.4763, height 5.5 mm	Ti	023.4752
Replacement Screw				
Occlusal Screw		for Titanium, Gold, Burn-Out and Variobase® Copings for Screw-retained Abutments, length 3.7 mm	TAN	023.4763













Bar Construction on Screw-retained Abutments, Plastic

Product	Image	Description	Material	Art.-No.
Bar Burn-out Coping for Ø 4.6 mm				
Burn-out Coping for Screw-retained Abutments		for Screw-retained Abutments Ø 4.6 mm, for bridges and bars, including screw 023.4763, height 11 mm	POM	023.4758
Replacement Screw				
Occlusal Screw		for Titanium, Gold, Burn-Out and Variobase® Copings for Screw-retained Abutments, length 3.7 mm	TAN	023.4763

Pre-milled Abutment Blanks

Product	Image	Description	Material	Art.-No.
Pre-milled Abutment Blank				
RB/WB Pre-milled Abutment Blank		for Medentika Holder, Ø 11.5 mm	TAN	062.4601
		for Medentika Holder, Ø 15.8 mm		062.4602
		for M-Series, Ø 12 mm		062.4603
Replacement Screws				
RB/WB Basal Screw		for RB/WB Temporary Abutments, Anatomic Abutments, Variobase® for Crown, Variobase® for Bridge/Bar Cylindrical, angled Screw-retained Abutments, Pre-milled Abutment Blanks, Gold Abutments, and angled Novaloc® Abutments, length 6.1 mm	TAN	065.0036

Novaloc®

Product	Image	Description	Material	Art.-No.
Novaloc® Abutments 0°				
RB/WB Novaloc®		straight, angulation 0°, Ø 3.8 mm, gingiva height 1.5 mm	TAV/ADLC	062.4501
		straight, angulation 0°, Ø 3.8 mm, gingiva height 2.5 mm		062.4502
		straight, angulation 0°, Ø 3.8 mm, gingiva height 3.5 mm		062.4503
		straight, angulation 0°, Ø 3.8 mm, gingiva height 4.5 mm		062.4504
		straight, angulation 0°, Ø 3.8 mm, gingiva height 5.5 mm		062.4505
		straight, angulation 0°, Ø 3.8 mm, gingiva height 6.5 mm		062.4506
Novaloc® Abutments 15°				
RB/WB Novaloc®		angled, angulation 15°, Ø 3.8 mm, gingiva height 2.5 mm	TAV/ADLC	062.4507
		angled, angulation 15°, Ø 3.8 mm, gingiva height 3.5 mm		062.4508
		angled, angulation 15°, Ø 3.8 mm, gingiva height 4.5 mm		062.4509
		angled, angulation 15°, Ø 3.8 mm, gingiva height 5.5 mm		062.4510
		angled, angulation 15°, Ø 3.8 mm, gingiva height 6.5 mm		062.4511
		angled, angulation 15°, Ø 3.8 mm, gingiva height 7.5 mm		062.4512
Replacement Screws				
RB/WB Basal Screw		for RB/WB Temporary Abutments, Anatomic Abutments, Variobase® for Crown, Variobase® for Bridge/Bar Cylindrical, angled Screw-retained Abutments, Pre-milled Abutment Blanks, Gold Abutments, and angled Novaloc® Abutments, length 6.1 mm	TAN	065.0036



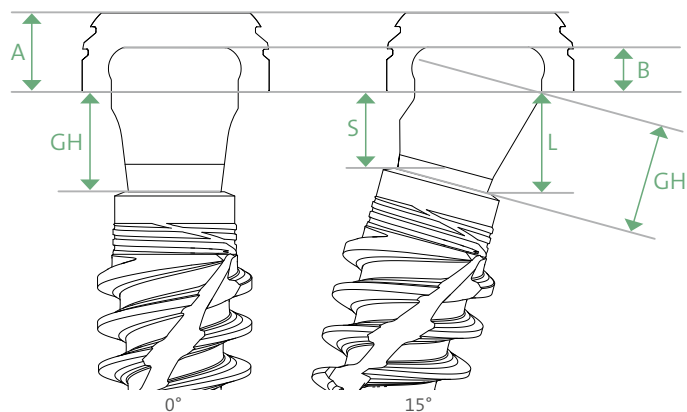











Novaloc® Abutment Dimensions









		Diameter (Ø)			
		Ø 3.8 mm (RB/WB)			
Angle		0°	15°		
GH	1.5 mm	062.4501	–	S	L
	2.5 mm	062.4502	062.4507	1.2 mm	1.9 mm
	3.5 mm	062.4503	062.4508	2.2 mm	2.9 mm
	4.5 mm	062.4504	062.4509	3.2 mm	3.9 mm
	5.5 mm	062.4505	062.4510	4.2 mm	4.9 mm
	6.5 mm	062.4506	062.4511	5.2 mm	5.9 mm
	7.5 mm	–	062.4512	6.2 mm	6.9 mm
Matrix			A	2.3 mm	
			B	1.4 mm	



Novaloc® Processing Packages and Matrix Housings

Product	Image	Description	Material	Art.-No.
Impression-taking/Master Cast Fabrication				
Novaloc® Impression Coping		red, packaging 4 pieces	PEEK	2010.722-NOV
Novaloc® Model Analog		blue, packaging 4 pieces	Al	2010.721-NOV
		red, angled, angulation 15°, packaging 4 pieces		2010.720-NOV
Processing Packages				
Novaloc® Processing Package Titanium		includes: 2010.701-NOV Matrix Housing, titanium (including Processing Insert), 2 pieces 2010.711-NOV Retention Insert, white (light), 2 pieces 2010.712-NOV Retention Insert, yellow (medium), 2 pieces 2010.713-NOV Retention Insert, green (strong), 2 pieces 2010.724-NOV Processing Collar, silicone, 2 pieces	Ti/POM/ PEEK/Silicone	2010.601-NOV
Novaloc® Processing Package PEEK		includes: 2010.702-NOV Matrix Housing, PEEK (including Processing Insert), 2 pieces 2010.711-NOV Retention Insert, white (light), 2 pieces 2010.712-NOV Retention Insert, yellow (medium), 2 pieces 2010.713-NOV Retention Insert, green (strong), 2 pieces 2010.724-NOV Processing Collar, silicone, 2 pieces	PEEK/POM/ Silicone	2010.611-NOV
Retention Inserts				
Novaloc® Retention Insert		red, extra-light, approx. 300 g, packaging 4 pieces	PEEK	2010.710-NOV
		white, light, approx. 750 g, packaging 4 pieces		2010.711-NOV
		yellow, medium, approx. 1200 g, packaging 4 pieces		2010.712-NOV
		green, strong, approx. 1650 g, packaging 4 pieces		2010.713-NOV
		blue, extra-strong, approx. 2050 g, packaging 4 pieces		2010.714-NOV
		black, ultra-strong, approx. 2450 g, packaging 4 pieces		2010.715-NOV
Matrix Housings				
Novaloc® Matrix Housing, Titanium		including Processing Insert, packaging 4 pieces	Ti/POM	2010.701-NOV
Novaloc® Matrix Housing, PEEK			PEEK/POM	2010.702-NOV
Novaloc® Matrix Housing, Extended			Ti/POM	2010.703-NOV



Novaloc® Tools and Auxiliary Parts

Product	Image	Description	Material	Art.-No.
Novaloc® Equipment Box		including 3 Instruments: 2010.731-NOV Novaloc® Processing Insert Removal Instrument (blue), 2010.741-NOV Novaloc® Retention Insert Instrument (brown), 2010.751-NOV Novaloc® Matrix Housing Extraction Instrument (gray)		2010.101-NOV
Novaloc® Block Out Spacer		white, packaging 4 pieces	POM	2010.723-NOV
Novaloc® Processing Collar		white, packaging 10 pieces	Silicone	2010.724-NOV
Novaloc® Processing Insert		white, packaging 4 pieces	POM	2010.725-NOV
Novaloc® Processing Insert Removal Instrument		blue	Al/Stainless steel	2010.731-NOV
Novaloc® Retention Insert Instrument		brown		2010.741-NOV
Novaloc® Matrix Housing Extraction Instrument		gray		2010.751-NOV



The Novaloc matrix system is also compatible with LOCATOR® abutments.



Impression Posts

Product	Image	Description	Material	Art.-No.
Impression Posts and Analog				
WB Impression Post Open Tray		short, with guide screw, length 16.5 mm	TAN	065.0032
		long, with guide screw, length 24 mm		065.0034
WB Impression Post Closed Tray		with guide screw, length 13 mm		065.4810

Digital Impression

Product	Image	Description	Material	Art.-No.
Digital Impression				
RB/WB CARES® Mono Scanbody		∅ 3.8 mm, height 10 mm	PEEK/TAN	065.0035
WB Repositionable Implant Analog		for fully digital workflow, length 17 mm	Stainless steel	065.0024
ScanPost S RB/WB L		for Dentsply® Sirona®, size L	TAN	065.0038

Analogs

Product	Image	Description	Material	Art.-No.
Analogs				
WB Implant Analog		length 12 mm	TAN	065.0022

Healing Abutments

Product	Image	Description	Material	Art.-No.
Healing Abutments				
WB Healing Abutment, for final abutments Ø 4.5 mm		Ø 6 mm, gingiva height 0.75 mm, abutment height 2 mm, (total 2.75 mm)	Ti	064.82015
		Ø 6 mm, gingiva height 0.75 mm, abutment height 4 mm, (total 4.75 mm)		064.82025
		Ø 6 mm, gingiva height 1.5 mm, abutment height 2 mm, (total 3.5 mm)		064.82125
		Ø 6 mm, gingiva height 1.5 mm, abutment height 4 mm, (total 5.5 mm)		064.82135
		Ø 7.5 mm, gingiva height 0.75 mm, abutment height 2 mm, (total 2.75 mm)		064.82035
		Ø 7.5 mm, gingiva height 0.75 mm, abutment height 4 mm, (total 4.75 mm)		064.82045
		Ø 7.5 mm, gingiva height 1.5 mm, abutment height 2 mm, (total 3.5 mm)		064.82145
		Ø 7.5 mm, gingiva height 1.5 mm, abutment height 4 mm, (total 5.5 mm)		064.82155

Always communicate the selected healing abutment to the dental lab

The BLX Healing Abutment selection determines the available options for the final restoration. Therefore, always communicate the implant diameter and the selected healing abutment to the restoring dentist or dental lab in order to facilitate the appropriate final abutment selection.

For more information refer to *Straumann® BLX Implant System – Healing Abutment selection, Quick Guide (704658/en)*.

Straumann® BLX Implant System – Healing Abutment selection Quick Guide

The total height of a BLX Healing Abutment consists of two parts:

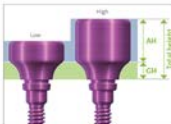

Gingiva Height (GH): Emerging part of the healing abutment, available in heights of 0.75 mm to 1.5 mm. Uniform profile throughout the BLX prosthetic portfolio.

Abutment Height (AH): Cylindrical part of the healing abutment, available in two heights - 2 mm (low) or 4 mm (high).

Always communicate the implant diameter and the selected healing abutment to the dental lab!

Please consider, that the BLX Healing Abutment selection determines the available options for the final restoration.

Slim profile single crown

R5/WB Healing Abutment Ø4.0/5.6/5.13 mm



GH: 1.5 mm
AH: 2.5 mm / 3.5 mm

After healing, no wide profile crown (WB) for bridge restoration possible, refer to the lab page.

Note: Use Healing Abutment Ø5.6, GH 1.5 mm for Variolux® A5 and R5/W5/AR5P Abutments.

Wide profile single crown, molar

WB Healing Abutment Ø6.0/7.5 mm



GH: 0.75 mm
AH: 1.5 mm

Note: For WB BLX Implants.

For more information refer to the Straumann® BLX Implant System Consistent Emergence Profile™ and Healing Abutment selection (704658/en).

Bridge

R5/WB Healing Abutment for Bridge/Bar Ø5.0 mm







GH: 1.1 mm

Note: Use this healing abutment if it has not yet been determined whether the restoration will consist of single crowns or a bridge.









straumann





Temporary Restorations

Product	Image	Description	Material	Art.-No.
VITA CAD-Temp®				
WB Temporary Abutment		Ø 5.5 mm, gingiva height 1.5 mm	PMMA/TAN	064.4390
Temporary Abutments				
WB Temporary Abutment		for crowns, Ø 5.5 mm, gingiva height 0.75 mm	TAN	064.4391
		for crowns, Ø 5.5 mm, gingiva height 1.5 mm		064.4392
Replacement Screw				
RB/WB Basal Screw		for RB/WB Temporary Abutments, Anatomic Abutments, Variobase® for Crown, Variobase® for Bridge/Bar Cylindrical, angled Screw-retained Abutments, Pre-milled Abutment Blanks, Gold Abutments, and angled Novaloc® Abutments, length 6.1 mm	TAN	065.0036

Cement or Screw-retained Restoration, Variobase®





Product	Image	Description	Material	Art.-No.
Variobase® Abutments				
WB Variobase® for Crown		including screw, Ø 5.5 mm, abutment height 5.5 mm, gingiva height 0.75 mm	TAN	062.4953
		including screw, Ø 5.5 mm, abutment height 5.5 mm, gingiva height 1.5 mm		062.4954
WB Variobase® C		for Dentsply® Sirona®, including screw 065.0036, Ø 5.5 mm, gingiva height 1.5 mm		062.4983
WB Variobase® for Crown AS		including screw, Ø 5.5 mm, abutment height 5.5 mm, gingiva height 1.5 mm		062.4971
Burn-out Copings				
WB Burn-out Coping		for Variobase® for Crown, Ø 5.5 mm, abutment height 5.5 mm	POM	065.0016
Burn-out Copings AS				
WB Burn-out Coping		angulation 25°, for Variobase® for Crown AS, Ø 5.5 mm, abutment height 5.5 mm	POM	065.0019
Replacement Screw				
RB/WB Basal Screw		for RB/WB Temporary Abutments, Anatomic Abutments, Variobase® for Crown, Variobase® for Bridge/Bar Cylindrical, angled Screw-retained Abutments, Pre-milled Abutment Blanks, Gold Abutments, and angled Novaloc® Abutments, length 6.1 mm	TAN	065.0036
RB/WB Basal Screw AS		for RB/WB Variobase® Crown AS, length 6.5 mm, only compatible with AS Screwdriver (green color-coding)		065.0037

Cement or Screw-retained Restoration, Gold Abutments

Product	Image	Description	Material	Art.-No.
Gold Abutment				
WB Gold Abutment		for crowns, including screw 065.0036, \varnothing 5.5 mm, gingiva height 1.5 mm	Ceramicor®/ POM	062.8410
Replacement Screw				
RB/WB Basal Screw		for RB/WB Temporary Abutments, Anatomic Abutments, Variobase® for Crown, Variobase® for Bridge/Bar Cylindrical, angled Screw-retained Abutments, Pre-milled Abutment Blanks, Gold Abutments, and angled Novaloc® Abutments, length 6.1 mm	TAN	065.0036

Ceramicor® is a non-oxidizing precious metal alloy for casting on precious metal alloys.

Pre-milled Abutment Blanks

Product	Image	Description	Material	Art.-No.
Pre-milled Abutment Blank				
WB Pre-milled Abutment Blank		for Medentika Holder, Ø 11.5 mm	TAN	062.4605
		for Medentika Holder, Ø 15.8 mm		062.4606
		for M-Series, Ø 12 mm		062.4607
Replacement Screw				
RB/WB Basal Screw		for RB/WB Temporary Abutments, Anatomic Abutments, Variobase® for Crown, Variobase® for Bridge/Bar Cylindrical, angled Screw-retained Abutments, Pre-milled Abutment Blanks, Gold Abutments, and angled Novaloc® Abutments, length 6.1 mm	TAN	065.0036



In this chapter you will find a comprehensive list of instruments and accessories for implants and prosthetic treatments.

More than just accessories: the basis of flawless execution

On the following pages, you will find **all the important instruments and demonstration materials** that complement the Straumann® BLX surgical and prosthetics portfolio, from drills and surgical cassettes to prosthetic auxiliary parts, screws and storage systems.

Straumann® Modular Cassette Selection Guide

The selection guide helps to define the required Modular Cassette parts and instruments needed for a specific indication. Each chapter includes an order list as well as a set-up overview which shows how to assemble the parts.

Art. Nr. 707824





Instruments and Accessories



Surgery	36
Planning Aids	36
Implant Bed Preparation Instruments	37
Instruments and Tools	39
Guided Surgery	41
Prosthetics	44
Prosthetic Tools	44
Storage Systems and Cassettes	45















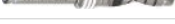

Planning Aids

Product	Image	Description	Material	Art.-No.
X-ray Reference Sphere				
X-ray Reference Sphere		Ø 5 mm, packaging 4 pieces, for single use	Stainless steel	049.076V4
X-ray Templates				
X-ray Reference Foil		for BLX Implants		065.0000

Needle Drills

Product	Image	Description	Material	Art.-No.
Needle Drills				
Needle Drill		short, Ø 1.6 mm, length 33 mm	Stainless steel	026.0054
		long, Ø 1.6 mm, length 41 mm		026.0056

VeloDrill™











Product	Image	Description	Material	Art.-No.
X VeloDrill™				
X Pilot VeloDrill™		short, Ø 2.2 mm, length 34 mm	Stainless steel	066.1301
X VeloDrill™		short, Ø 2.8 mm, length 34 mm		066.1302
		short, Ø 3.2 mm, length 34 mm		066.1303
		short, Ø 3.5 mm, length 34 mm		066.1304
		short, Ø 3.7 mm, length 34 mm		066.1305
		short, Ø 4.2 mm, length 34 mm		066.1306
		short, Ø 4.7 mm, length 34 mm		066.1307
		short, Ø 5.2 mm, length 34 mm		066.1308
		short, Ø 6.2 mm, length 34 mm		066.1309
X Pilot VeloDrill™		long, Ø 2.2 mm, length 42 mm		066.1701
X VeloDrill™		long, Ø 2.8 mm, length 42 mm		066.1702
		long, Ø 3.2 mm, length 42 mm		066.1703
		long, Ø 3.5 mm, length 42 mm		066.1704
		long, Ø 3.7 mm, length 42 mm		066.1705
		long, Ø 4.2 mm, length 42 mm	066.1706	
		long, Ø 4.7 mm, length 42 mm	066.1707	

Instruments and Accessories





Note: For the medium-length VeloDrill™ (L 38mm), please see page 41 under the section Guided Surgery.







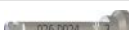









Alignment Pins and Depth Gauges

Product	Image	Description	Material	Art.-No.
Alignment Pins and Depth Gauges				
Alignment Pin		length 27 mm, \varnothing 2.2 mm	TAN	046.799
Depth Gauge		length 27 mm, \varnothing 2.8 mm		046.800
		length 27 mm, \varnothing 3.2 mm		046.801
		length 27 mm, \varnothing 3.5 mm		046.802
		length 27 mm, \varnothing 3.7 mm		046.803
		length 27 mm, \varnothing 4.2 mm		046.804
		length 27 mm, \varnothing 4.7 mm		046.805
		length 27 mm, \varnothing 5.2 mm		046.806
		length 27 mm, \varnothing 6.2 mm		046.807
Implant Depth Gauge		\varnothing 1.5/2.0 mm		066.2000

















Bone Profilers

Product	Image	Description	Material	Art.-No.
Bone Profilers for Bone Level				
BL Bone Profiler 1		length 23 mm, \varnothing 5.2 mm	Stainless steel	026.0022
BL Bone Profiler 2		length 23 mm, \varnothing 6.6 mm		026.0023
BL Bone Profiler 3		length 23 mm, \varnothing 6 mm		026.0024
BLX Guiding Cylinder		for Bone Profiler, length 10.8 mm, \varnothing 2.9 mm	TAN	066.00255

Auxiliary Instruments

Product	Image	Description	Material	Art.-No.
Implant Drivers				
TorcFit™ Implant Driver		Surgical Handle	Stainless steel	066.4000
		for handpiece, short, length 21 mm		066.4101
		for handpiece, medium, length 26 mm		066.4107
		for handpiece, long, length 31 mm		066.4102
		for handpiece, extra long, length 36 mm		066.4108
		for Ratchet, short, length 21 mm		066.4201
		for Ratchet, medium, length 26 mm		066.4207
		for Ratchet, long, length 31 mm		066.4202
TorcFit™ Implant Driver screw-retained		for Ratchet, screw-retained, short		066.4205
		for Ratchet, screw-retained, long		066.4206
Instruments				
Ratchet		including Service Instruments, length 84 mm	Stainless steel	046.119
Torque Control Device		for Ratchet, length 82 mm, Torque markings: 0 / 15 / 35 Ncm		046.049
BLX Torque Control Device		for Ratchet, for BLX and TLX, surgical, length 82 mm, Torque markings: 0 / 35 / 50 / 80 Ncm		066.1100
Holding Key		length 85 mm		046.064
Tweezers		with titanium plasma-coated tips, length 105 mm		Stainless steel/Ti





Auxiliary Instruments

Product	Image	Description	Material	Art.-No.
Screwdrivers				
SCS Screwdriver		for Ratchet, extra short, length 15 mm	Stainless steel	046.400
		for Ratchet, short, length 21 mm		046.401
		for Ratchet, long, length 27 mm		046.402
		for handpiece, extra-short, length 20 mm		046.410
		for handpiece, short, length 26 mm		046.411
		for handpiece, long, length 32 mm		046.412
AS Screwdriver		for Ratchet, extra-short, length 15 mm	Stainless steel	046.786
		for Ratchet, short, length 21 mm		046.787
		for Ratchet, long, length 27 mm		046.788
		for handpiece, extra-short, length 20 mm		046.789
		for handpiece, short, length 26 mm		046.790
		for handpiece, long, length 32 mm		046.791
AS Screwdriver Handling Aid				046.792
Abutment removal kit				
RB/WB Abutment-Removal Screw		to push out Abutments, which cannot be removed from the implant due to friction	TAN	065.0007
Removal Tool		for RB/WB Basal Screw, left-hand, length 27 mm	Stainless steel	065.0008
		for RB/WB Basal Screw, left-hand, length 21 mm		065.0009
Miscellaneous Auxiliary Instruments				
Drill Extender		length 23 mm	Stainless steel	040.563





Implant Bed Preparation Instruments

Product	Image	Description	Material	Art.-No.
Guided Milling Cutters				
Milling Cutter		guided, length 32.5 mm, Ø 2.2 mm	Stainless steel	026.0144
		guided, length 32.5 mm, Ø 2.8 mm		034.215
		guided, length 32.5 mm, Ø 3.5 mm		034.415
		guided, length 32.5 mm, Ø 4.2 mm		034.615
Mucosa Punch		guided, length 30 mm, Ø 3.4 mm		034.010
		guided, length 30 mm, Ø 4 mm		034.011
		guided, length 30 mm, Ø 4.7 mm		034.012
Guided X VeloDrill™				
X Pilot VeloDrill™		short, Ø 2.2 mm, length 34 mm	Stainless steel	066.1301
X VeloDrill™		short, Ø 2.8 mm, length 34 mm		066.1302
		short, Ø 3.2 mm, length 34 mm		066.1303
		short, Ø 3.5 mm, length 34 mm		066.1304
		short, Ø 3.7 mm, length 34 mm		066.1305
		short, Ø 4.2 mm, length 34 mm		066.1306
		short, Ø 4.7 mm, length 34 mm		066.1307
		short, Ø 5.2 mm, length 34 mm		066.1308
	short, Ø 6.2 mm, length 34 mm	066.1309		
X Pilot VeloDrill™		medium, Ø 2.2 mm, length 38 mm	066.1501	
X VeloDrill™		medium, Ø 2.8 mm, length 38 mm	066.1502	
		medium, Ø 3.2 mm, length 38 mm	066.1503	
		medium, Ø 3.5 mm, length 38 mm	066.1504	
		medium, Ø 3.7 mm, length 38 mm	066.1505	
		medium, Ø 4.2 mm, length 38 mm	066.1506	
		medium, Ø 4.7 mm, length 38 mm	066.1507	
		medium, Ø 5.2 mm, length 38 mm	066.1508	
	medium, Ø 6.2 mm, length 38 mm	066.1509		
X Pilot VeloDrill™		long, Ø 2.2 mm, length 42 mm	066.1701	
X VeloDrill™		long, Ø 2.8 mm, length 42 mm	066.1702	
		long, Ø 3.2 mm, length 42 mm	066.1703	
		long, Ø 3.5 mm, length 42 mm	066.1704	
		long, Ø 3.7 mm, length 42 mm	066.1705	
		long, Ø 4.2 mm, length 42 mm	066.1706	
		long, Ø 4.7 mm, length 42 mm	066.1707	

Guided Surgery Templates





















Product	Image	Description	Material	Art.-No.
Sleeves for Straumann® Guided Surgery				
T-Sleeve		self-locking, guided, height 5 mm, Ø 5 mm, packaging 4 pieces	PEEK	034.299V4
		guided, height 5 mm, Ø 5 mm, packaging 4 pieces	Stainless steel	034.053V4
		guided, height 6 mm, Ø 2.8 mm, packaging 4 pieces		034.055V4
		guided, height 6 mm, Ø 2.2 mm, packaging 4 pieces		046.712V4
Template Fixation Pin		T-Sleeve for lateral Template Fixation Pin	Ti	034.283

Guided Implant Drivers















Product	Image	Description	Material	Art.-No.
Implant Drivers				
TorcFit™ BLX Guided Implant Driver		for Ratchet, for BLX, guided, screw-retained	Stainless steel	066.4401
		for handpiece, for BLX, guided		066.4403
		for Ratchet, for BLX, guided		066.4404
Stop Key		Stop key for guided implants		034.006

The laser markings on the TorcFit™ guided implant drivers are provided for identification. Please be aware that the correct guided implant drivers must be used for the corresponding implant type (S TLX, SP TLX, BLX). Using the wrong type could result in implant placement deeper than planned.









Auxiliary Instruments

Product	Image	Description	Material	Art.-No.
Drill Handle, self locking compatible with PEEK T-sleeves 034.299V4				
Drill Handle		self-locking, stop 1/3 mm, Ø 2.2 mm	Stainless steel	034.291
		self-locking, stop 1/3 mm, Ø 2.8 mm		034.292
		self-locking, stop 1/3 mm, Ø 3.2 mm		034.293
		self-locking, stop 1/3 mm, Ø 3.5 mm		034.294
		self-locking, stop 1/3 mm, Ø 3.7 mm		034.295
		self-locking, stop 1/3 mm, Ø 4.2 mm		034.296
Drill Handle, conventional, compatible with metal T-sleeves 034.053V4				
Drill Handle		stop 1/3 mm, Ø 2.2 mm	Stainless steel	026.0147
		stop 1/3 mm, Ø 2.8 mm		026.0148
		stop 1/3 mm, Ø 3.2 mm		026.0149
		stop 1/3 mm, Ø 3.5 mm		026.0150
		stop 1/3 mm, Ø 3.7 mm		026.0151
		stop 1/3 mm, Ø 4.2 mm		026.0152
Template Fixation				
Template Fixation Pin		guided, Ø 5/2.8 mm	Stainless steel	034.285
		guided, Ø 5/3.2 mm		034.286
		guided, Ø 5/3.5 mm		034.287
		guided, Ø 5/3.7 mm		034.288
		guided, Ø 5/4.2 mm		034.289
		guided, Ø 2.8/2.8 mm		034.298
Template Fixation Pin		Drill for Template Fixation Pin, Ø 1.3 mm		034.284
Template Fixation Pin		Lateral Template Fixation Pin, Ø 1.3 mm	Ti	034.282









Prosthetic Tools

Product	Image	Description	Material	Art.-No.
Tool				
Ratchet		including Service Instruments, length 84 mm	Stainless steel	046.119
Torque Control Device		for Ratchet, length 82 mm, Torque markings: 0 / 15 / 35 Ncm		046.049
SCS Screwdriver				
SCS Screwdriver		for Ratchet, extra short, length 15 mm	Stainless steel	046.400
		for Ratchet, short, length 21 mm		046.401
		for Ratchet, long, length 27 mm		046.402
		for handpiece, extra-short, length 20 mm		046.410
		for handpiece, short, length 26 mm		046.411
		for handpiece, long, length 32 mm		046.412
AS Screwdriver		for Ratchet, extra-short, length 15 mm	046.786	
		for Ratchet, short, length 21 mm	046.787	
		for Ratchet, long, length 27 mm	046.788	
		for handpiece, extra-short, length 20 mm	046.789	
		for handpiece, short, length 26 mm	046.790	
		for handpiece, long, length 32 mm	046.791	
AS Screwdriver Handling Aid			046.792	

BLX Cassettes, Non-guided

Product	Image	Description	Material	Art.-No.
Straumann® Modular Cassette		A Module		041.761
A Module, Grommet Tray		3 small, 3 large grommets		041.764
		6 small grommets		041.762
A Module, Ratchet Tray		for Ratchet 046.119, Torque Device 046.049 or 066.1100 and Holding Key 046.064		041.766
A Module, Tweezer Tray		for Tweezer 046.095		041.770
A Module, Implant Depth Gauge Tray		for Implant Depth Gauge 066.2000		041.771
Straumann® Modular Cassette		B Module		041.776
B Module, Fully Tapered Tray				041.777







BLX Cassettes, Guided

Product	Image	Description	Material	Art.-No.
Straumann® Modular Cassette		A Module		041.761
A Module, Grommet Tray		3 small, 3 large grommets		041.764
A Module, Ratchet Tray		for Ratchet 046.119, Torque Device 046.049 or 066.1100 and Holding Key 046.064		041.766
A Module, Stop Key Tray		for Stop Key 034.006		041.768
A Module, Implant Depth Gauge Tray		for Implant Depth Gauge 066.2000		041.771
Straumann® Modular Cassette		B Module		041.776
B Module, Guided Fully Tapered Tray				041.780
Straumann® Modular Cassette		C Module, Guided Surgery		041.772

Instruments and Accessories

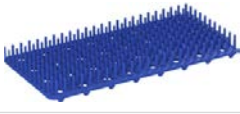

Auxiliary Instruments

Product	Image	Description	Material	Art.-No.
A Module, Grommet Tray		6 small grommets		041.762
		6 large grommets		041.763
		3 medium, 3 large grommets		041.765
A Module, Tweezer Tray		for Tweezer 046.095		041.770
Straumann® Modular Cassette		C Module, Spare Tools		041.773
Ultrasonic Mat		mat for ultrasonic baths		041.774
Spare Label Plate		Label plates for the different Implant Systems		041.775



Information and Index:

For a quick and easy overview, you can find all Straumann products listed by item number with the corresponding page numbers. Furthermore, you can find important advice and additional information on Straumann and Straumann products.

Information and Index

Index

50



Index by item number

Art.No.	Article	Page
023.0028	Variobase® for Bridge/Bar Cylindrical Coping, f. Screw-ret. Abut. Ø 4.6mm, incl. screw and Cement. Aid, Ø 5.1mm, AH 4mm, TAN	21
023.0032	NC/RC Burn-out Cop. f. Variobase® f. Bridge/Bar Cylin., Coping Screw-retained Abutment Ø 4.6mm, POM	21
023.0032V4	NC/RC Burn-out Cop. f. Variobase® f. Bridge/Bar Cylin., Coping Screw-retained Abutment Ø 4.6mm, POM	21
023.0033V2	Plastic Coping, for Immediate Temporary Abutment, PMMA	15
023.4747	Coping for screw-retained abutment, Ti, Crown, Ø 4.6mm	21
023.4748	Burn-out coping for screw-retained abutment, POM, Crown, Ø 4.6mm	21
023.4751	Coping for screw-retained abutment, Ti, Bridge, Ø 4.6mm	21
023.4752	Coping for screw-retained abutment, Ti, Bar, Ø 4.6mm	23
023.4753	Coping for screw-retained abutment, Crown, Ø 4.6mm, Ceramicor®/POM	21
023.4754	Coping for screw-retained abutment, Bridge, Ø 4.6mm, Ceramicor®/POM	21
023.4755	Coping for screw-retained abutment, Bar, Ø 4.6mm, Ceramicor®	22
023.4756	Analog for screw-retained abutment, TAN, straight 0°, Ø 4.6mm	20
023.4757	Analog for screw-retained abutment, TAN, angled 17°/30°, Ø 4.6mm	20
023.4758	Burn-out coping f. screw-retained abut., POM, Bridge/Bar, Ø 4.6mm	21, 24
023.4763	Occlusal screw, TAN, for coping, screw-retained abutment	17, 19, 21, 22, 23, 24
024.0020-04	Protective Cap for Screw-retained Abutment, Ø 4.6mm, H 4.5mm, wide, PEEK/TAN	20
024.0023	Temporary Coping for Screw-retained Abutment, Crown, Ø 4.6mm, TAN	21
024.0024	Temporary Coping for Screw-retained Abutment, Bridge, Ø 4.6mm, TAN	21
024.4323-04	Protective cap for screw-retained abutment, Ø 4.6mm, H 5.1mm, PEEK/TAN	20
024.4324-04	Protective cap for screw-retained abutment, Ø 4.6mm, H 6.6mm, PEEK/TAN	20
024.4325-04	Protective cap for screw-retained abutment, Ø 4.6mm, H 8.1mm, PEEK/TAN	20
025.0001	CARES® Mono Scanbody for screw-retained abutment, abutment level, Ø 4.6mm, PEEK/TAN	20
025.0005	Polishing Aid, for Screw-retained Abutments Ø 4.6mm, TAN	20
025.0005V4	Polishing Aid, for Screw-retained Abutments Ø 4.6mm, TAN	20
025.0006	Lab Processing Screw, for Screw-retained Abutments, stainless steel	20
025.0008	Repositionable Analog, stainless steel, for Screw-retained Abutments Ø 4.6 mm	20
025.0009	Transfer and Alignment Pin, for Screw-retained Abutments, TAN	21
025.0012	Impression Post f. open tray f. screw-ret. abut., abut. level, Ø 4.6mm, non-engaging, TAN	20
025.0014	Impression Post f. closed tray f. screw-ret. abut., abut. level, Ø 4.6mm, non-engaging, TAN/POM	20
025.0050	Analog for Screw-retained Abutments, edentulous, straight 0°, Ø 4.6mm, TAN	20
025.0052	Lab Processing Screw, for Screw-retained Abutments, L 10mm, stainless steel	20
025.0073V4	RB/WB Plan Abutment, for Screw-retained Abutments 0°, GH 1.5/2.5/3.5/4.5mm, POM	19
025.0074V4	RB/WB Plan Abutment, for Screw-retained Abutments 17°, GH 3.5/4.5/5.5mm, POM	19
025.0075V4	RB/WB Plan Abutment, for Screw-retained Abutments 30°, GH 3.5/4.5/5.5mm, POM	19
025.2244	Impression post for open tray, TAN, for screw-ret. abut., abut. level, 0°, D 4.6mm	20
025.2246	Impression post for closed tray, abutment level, for screw-retained abutment, D 4.6mm, TAN/POM	20
026.0016	Straumann® Planning Guide	21
026.0022	BL Bone Profiler 1, Ø 5.2mm, L 23mm, stainless steel	38
026.0023	BL Bone Profiler 2, Ø 6.6mm, L 23mm, stainless steel	38
026.0024	BL Bone Profiler 3, Ø 6mm, L 23mm, stainless steel	38
026.0054	Needle Drill, short, Ø 1.6mm, L 33mm, stainless steel	37
026.0056	Needle Drill, long, Ø 1.6mm, L 41mm, stainless steel	37
026.0144	Milling cutter, Ø 2.2mm, guided, stainless steel	41
026.0147	Drill handle, Ø 2.2mm, 1mm/3mm stop, stainless steel	43
026.0148	Drill handle, Ø 2.8mm, 1mm/3mm stop, stainless steel	43
026.0149	Drill Handle, Ø 3.2mm, 1mm/3mm stop, stainless steel	43
026.0150	Drill handle, Ø 3.5mm, 1mm/3mm stop, stainless steel	43
026.0151	Drill Handle, Ø 3.7mm, 1mm/3mm stop, stainless steel	43
026.0152	Drill handle, Ø 4.2mm, 1mm/3mm stop, stainless steel	43
034.006	Stop key for guided implants, S/SP/TE/BL, stainless steel	42
034.010	Mucosa punch Ø 3.4mm, guided, L 30mm, stainless steel	41
034.011	Mucosa punch Ø 4.0mm, guided, L 30mm, stainless steel	41
034.012	Mucosa punch Ø 4.7mm, guided, L 30mm, stainless steel	41
034.053V4	T-sleeve, Ø 5mm, H 5mm, guided, stainless steel	42
034.055V4	T-sleeve, Ø 2.8mm, H 6mm, guided, stainless steel	42
034.215	Milling cutter, Ø 2.8mm, guided, L 32.5mm, stainless steel	41
034.282	Template Fixation Pin, Ø 1.3mm, Ti	43
034.283	T-Sleeve for Template Fixation Pin, Ti	42
034.284	Drill for Template Fixation Pin, Ø 1.3mm, stainless steel	43
034.285	Template Fixation Pin, Ø 5/2.8mm, guided, stainless steel	43
034.286	Template Fixation Pin, Ø 5/3.2mm, guided, stainless steel	43
034.287	Template Fixation Pin, Ø 5/3.5mm, guided, stainless steel	43
034.288	Template Fixation Pin, Ø 5/3.7mm, guided, stainless steel	43
034.289	Template Fixation Pin, Ø 5/4.2mm, guided, stainless steel	43
034.291	Drill handle, self-locking, Ø 2.2mm, 1mm/3mm stop, stainless steel, self-locking, Ø 2.2mm, 1mm/3mm stop, stainless steel	43
034.292	Drill handle, self-locking, Ø 2.8mm, 1mm/3mm stop, stainless steel, self-locking, Ø 2.8mm, 1mm/3mm stop, stainless steel	43



Index by item number

Art.No.	Article	Page
034.293	Drill handle, self-locking, Ø 3.2mm, 1mm/3mm stop, stainless steel	43
034.294	Drill handle, self-locking, Ø 3.5mm, 1mm/3mm stop, stainless steel, self-locking, Ø 3.5mm, 1mm/3mm stop, stainless steel	43
034.295	Drill handle, self-locking, Ø 3.7mm, 1mm/3mm stop, stainless steel	43
034.296	Drill handle, self-locking, Ø 4.2mm, 1mm/3mm stop, stainless steel, self-locking, Ø 4.2mm, 1mm/3mm stop, stainless steel	43
034.298	Template Fixation Pin, Ø 2.8/2.8mm, guided, stainless steel	43
034.299V4	T-Sleeve, self-locking, guided, Ø 5mm, H 5mm, PEEK	42
034.415	Milling cutter, Ø 3.5mm, guided, L 32.5mm, stainless steel	41
034.615	Milling cutter, Ø 4.2mm, guided, L 32.5mm, stainless steel	41
040.563	Drill Extender, L 23mm, stainless steel	40
041.761	Straumann® Modular Cassette, A Module	45, 46
041.762	A Module, Grommet Tray, 6 small	45, 47
041.763	A Module, Grommet Tray, 6 large	47
041.764	A Module, Grommet Tray, 3 small, 3 large	45, 46
041.765	A Module, Grommet Tray, 3 medium 3 large	47
041.766	A Module, Ratchet Tray	45, 46
041.768	A Module, Stop Key Tray	46
041.770	A Module, Tweezer Tray	45, 47
041.771	A Module, Depth Probe Tray	45, 46
041.772	Straumann® Modular Cassette, C Module, Guided Surgery	46
041.773	Straumann® Modular Cassette, C Module, Spare Tools	47
041.774	Ultrasonic Mat	47
041.775	Spare Label Plate	47
041.776	Straumann® Modular Cassette, B Module	45, 46
041.777	B Module, Fully Tapered Tray	45
041.780	B Module, Guided Fully Tapered Tray	46
046.049	Torque control device for ratchet, stainless steel	39, 44
046.064	Holding key, L 85mm, stainless steel	39
046.095	Tweezers with titanium plasma-coated tips, L 105mm, Ti/stainless steel	39
046.119	Ratchet, including service instrument, L 84mm, stainless steel	39, 44
046.400	SCS Screwdriver, for ratchet, x-short, L 15mm, stainless steel	40, 44
046.401	SCS Screwdriver, for ratchet, short, L 21mm, stainless steel	40, 44
046.402	SCS Screwdriver, for ratchet, long, L 27mm, stainless steel	40, 44
046.410	SCS Screwdriver for handpiece, x-short, L 20mm, stainless steel	40, 44
046.411	SCS Screwdriver for handpiece, short, L 26mm, stainless steel	40, 44
046.412	SCS Screwdriver for handpiece, long, L 32mm, stainless steel	40, 44
046.421	Hexagonal screwdriver, L 30mm, stainless steel	21
046.712V4	T-sleeve, Ø 2.2mm, H 6mm, guided, stainless steel	42
046.786	AS Screwdriver for ratchet, extra-short, L 15mm, stainless steel	40, 44
046.787	AS Screwdriver for ratchet, short, L 21mm, stainless steel	40, 44
046.788	AS Screwdriver for ratchet, long, L 27mm, stainless steel	40, 44
046.789	AS Screwdriver for handpiece, extra-short, L 20mm, stainless steel	40, 44
046.790	AS Screwdriver for handpiece, short, L 26mm, stainless steel	40, 44
046.791	AS Screwdriver for handpiece, long, L 32mm, stainless steel	40, 44
046.792	Screwdriver Handling Aid AS, stainless steel	40, 44
046.799	Alignment Pin, Ø 2.2mm, L 27mm, TAN	38
046.800	Depth Gauge, Ø 2.8mm, L 27mm, TAN	38
046.801	Depth Gauge, Ø 3.2mm, L 27mm, TAN	38
046.802	Depth Gauge, Ø 3.5mm, L 27mm, TAN	38
046.803	Depth Gauge, Ø 3.7mm, L 27mm, TAN	38
046.804	Depth Gauge, Ø 4.2mm, L 27mm, TAN	38
046.805	Depth Gauge, Ø 4.7mm, L 27mm, TAN	38
046.806	Depth Gauge, Ø 5.2mm, L 27mm, TAN	38
046.807	Depth Gauge, Ø 6.2mm, L 27mm, TAN	38
049.076V4	X-ray reference sphere, Ø 5.0mm, stainless steel	36
061.3308	BLX Implant, Ø 3.5mm RB, SLActive® 8mm, Roxolid®	6
061.3310	BLX Implant, Ø 3.5mm RB, SLActive® 10mm, Roxolid®	6
061.3312	BLX Implant, Ø 3.5mm RB, SLActive® 12mm, Roxolid®	6
061.3314	BLX Implant, Ø 3.5mm RB, SLActive® 14mm, Roxolid®	6
061.3316	BLX Implant, Ø 3.5mm RB, SLActive® 16mm, Roxolid®	6
061.3318	BLX Implant, Ø 3.5mm RB, SLActive® 18mm, Roxolid®	6
061.3508	BLX Implant, Ø 3.5mm RB, SLA® 8mm, Roxolid®	7
061.3510	BLX Implant, Ø 3.5mm RB, SLA® 10mm, Roxolid®	7
061.3512	BLX Implant, Ø 3.5mm RB, SLA® 12mm, Roxolid®	7
061.3514	BLX Implant, Ø 3.5mm RB, SLA® 14mm, Roxolid®	7
061.3516	BLX Implant, Ø 3.5mm RB, SLA® 16mm, Roxolid®	7
061.3518	BLX Implant, Ø 3.5mm RB, SLA® 18mm, Roxolid®	7



Index by item number

Art.No.	Article	Page
061.4306	BLX Implant, Ø 3.75mm RB, SLActive® 6mm, Roxolid®	6
061.4308	BLX Implant, Ø 3.75mm RB, SLActive® 8mm, Roxolid®	6
061.4310	BLX Implant, Ø 3.75mm RB, SLActive® 10mm, Roxolid®	6
061.4312	BLX Implant, Ø 3.75mm RB, SLActive® 12mm, Roxolid®	6
061.4314	BLX Implant, Ø 3.75mm RB, SLActive® 14mm, Roxolid®	6
061.4316	BLX Implant, Ø 3.75mm RB, SLActive® 16mm, Roxolid®	6
061.4318	BLX Implant, Ø 3.75mm RB, SLActive® 18mm, Roxolid®	6
061.4506	BLX Implant, Ø 3.75mm RB, SLA® 6mm, Roxolid®	7
061.4508	BLX Implant, Ø 3.75mm RB, SLA® 8mm, Roxolid®	7
061.4510	BLX Implant, Ø 3.75mm RB, SLA® 10mm, Roxolid®	7
061.4512	BLX Implant, Ø 3.75mm RB, SLA® 12mm, Roxolid®	7
061.4514	BLX Implant, Ø 3.75mm RB, SLA® 14mm, Roxolid®	7
061.4516	BLX Implant, Ø 3.75mm RB, SLA® 16mm, Roxolid®	7
061.4518	BLX Implant, Ø 3.75mm RB, SLA® 18mm, Roxolid®	7
061.5306	BLX Implant, Ø 4.0mm RB, SLActive® 6mm, Roxolid®	6
061.5308	BLX Implant, Ø 4.0mm RB, SLActive® 8mm, Roxolid®	6
061.5310	BLX Implant, Ø 4.0mm RB, SLActive® 10mm, Roxolid®	6
061.5312	BLX Implant, Ø 4.0mm RB, SLActive® 12mm, Roxolid®	6
061.5314	BLX Implant, Ø 4.0mm RB, SLActive® 14mm, Roxolid®	6
061.5316	BLX Implant, Ø 4.0mm RB, SLActive® 16mm, Roxolid®	6
061.5318	BLX Implant, Ø 4.0mm RB, SLActive® 18mm, Roxolid®	6
061.5506	BLX Implant, Ø 4.0mm RB, SLA® 6mm, Roxolid®	7
061.5508	BLX Implant, Ø 4.0mm RB, SLA® 8mm, Roxolid®	7
061.5510	BLX Implant, Ø 4.0mm RB, SLA® 10mm, Roxolid®	7
061.5512	BLX Implant, Ø 4.0mm RB, SLA® 12mm, Roxolid®	7
061.5514	BLX Implant, Ø 4.0mm RB, SLA® 14mm, Roxolid®	7
061.5516	BLX Implant, Ø 4.0mm RB, SLA® 16mm, Roxolid®	7
061.5518	BLX Implant, Ø 4.0mm RB, SLA® 18mm, Roxolid®	7
061.6306	BLX Implant, Ø 4.5mm RB, SLActive® 6mm, Roxolid®	6
061.6308	BLX Implant, Ø 4.5mm RB, SLActive® 8mm, Roxolid®	6
061.6310	BLX Implant, Ø 4.5mm RB, SLActive® 10mm, Roxolid®	6
061.6312	BLX Implant, Ø 4.5mm RB, SLActive® 12mm, Roxolid®	6
061.6314	BLX Implant, Ø 4.5mm RB, SLActive® 14mm, Roxolid®	6
061.6316	BLX Implant, Ø 4.5mm RB, SLActive® 16mm, Roxolid®	6
061.6318	BLX Implant, Ø 4.5mm RB, SLActive® 18mm, Roxolid®	6
061.6506	BLX Implant, Ø 4.5mm RB, SLA® 6mm, Roxolid®	7
061.6508	BLX Implant, Ø 4.5mm RB, SLA® 8mm, Roxolid®	7
061.6510	BLX Implant, Ø 4.5mm RB, SLA® 10mm, Roxolid®	7
061.6512	BLX Implant, Ø 4.5mm RB, SLA® 12mm, Roxolid®	7
061.6514	BLX Implant, Ø 4.5mm RB, SLA® 14mm, Roxolid®	7
061.6516	BLX Implant, Ø 4.5mm RB, SLA® 16mm, Roxolid®	7
061.6518	BLX Implant, Ø 4.5mm RB, SLA® 18mm, Roxolid®	7
061.7306	BLX Implant, Ø 5.0mm WB, SLActive® 6mm, Roxolid®	8
061.7308	BLX Implant, Ø 5.0mm WB, SLActive® 8mm, Roxolid®	8
061.7310	BLX Implant, Ø 5.0mm WB, SLActive® 10mm, Roxolid®	8
061.7312	BLX Implant, Ø 5.0mm WB, SLActive® 12mm, Roxolid®	8
061.7314	BLX Implant, Ø 5.0mm WB, SLActive® 14mm, Roxolid®	8
061.7316	BLX Implant, Ø 5.0mm WB, SLActive® 16mm, Roxolid®	8
061.7318	BLX Implant, Ø 5.0mm WB, SLActive® 18mm, Roxolid®	8
061.7506	BLX Implant, Ø 5.0mm WB, SLA® 6mm, Roxolid®	9
061.7508	BLX Implant, Ø 5.0mm WB, SLA® 8mm, Roxolid®	9
061.7510	BLX Implant, Ø 5.0mm WB, SLA® 10mm, Roxolid®	9
061.7512	BLX Implant, Ø 5.0mm WB, SLA® 12mm, Roxolid®	9
061.7514	BLX Implant, Ø 5.0mm WB, SLA® 14mm, Roxolid®	9
061.7516	BLX Implant, Ø 5.0mm WB, SLA® 16mm, Roxolid®	9
061.7518	BLX Implant, Ø 5.0mm WB, SLA® 18mm, Roxolid®	9
061.8306	BLX Implant, Ø 5.5mm WB, SLActive® 6mm, Roxolid®	8
061.8308	BLX Implant, Ø 5.5mm WB, SLActive® 8mm, Roxolid®	8
061.8310	BLX Implant, Ø 5.5mm WB, SLActive® 10mm, Roxolid®	8
061.8312	BLX Implant, Ø 5.5mm WB, SLActive® 12mm, Roxolid®	8
061.8314	BLX Implant, Ø 5.5mm WB, SLActive® 14mm, Roxolid®	8
061.8316	BLX Implant, Ø 5.5mm WB, SLActive® 16mm, Roxolid®	8
061.8506	BLX Implant, Ø 5.5mm WB, SLA® 6mm, Roxolid®	9
061.8508	BLX Implant, Ø 5.5mm WB, SLA® 8mm, Roxolid®	9
061.8510	BLX Implant, Ø 5.5mm WB, SLA® 10mm, Roxolid®	9
061.8512	BLX Implant, Ø 5.5mm WB, SLA® 12mm, Roxolid®	9



Index by item number

Art.No.	Article	Page
061.8514	BLX Implant, Ø 5.5mm WB, SLA® 14mm, Roxolid®	9
061.8516	BLX Implant, Ø 5.5mm WB, SLA® 16mm, Roxolid®	9
061.9306	BLX Implant, Ø 6.5mm WB, SLActive® 6mm, Roxolid®	8
061.9308	BLX Implant, Ø 6.5mm WB, SLActive® 8mm, Roxolid®	8
061.9310	BLX Implant, Ø 6.5mm WB, SLActive® 10mm, Roxolid®	8
061.9312	BLX Implant, Ø 6.5mm WB, SLActive® 12mm, Roxolid®	8
061.9314	BLX Implant, Ø 6.5mm WB, SLActive® 14mm, Roxolid®	8
061.9316	BLX Implant, Ø 6.5mm WB, SLActive® 16mm, Roxolid®	8
061.9506	BLX Implant, Ø 6.5mm WB, SLA® 6mm, Roxolid®	9
061.9508	BLX Implant, Ø 6.5mm WB, SLA® 8mm, Roxolid®	9
061.9510	BLX Implant, Ø 6.5mm WB, SLA® 10mm, Roxolid®	9
061.9512	BLX Implant, Ø 6.5mm WB, SLA® 12mm, Roxolid®	9
061.9514	BLX Implant, Ø 6.5mm WB, SLA® 14mm, Roxolid®	9
061.9516	BLX Implant, Ø 6.5mm WB, SLA® 16mm, Roxolid®	9
062.4103	RB/WB Anatomic Abutment, straight, GH 2.5mm, TAN	16
062.4104	RB/WB Anatomic Abutment, straight, GH 3.5mm, TAN	16
062.4153	RB/WB Anatomic Abutment, angled 17°, GH 2.5mm, TAN	16
062.4154	RB/WB Anatomic Abutment, angled 17°, GH 3.5mm, TAN	16
062.4410	RB/WB Gold Abutment, for Crown, Ø 3.8mm, GH 1.5mm, Ceramicor®/POM	16
062.4420	RB/WB Gold Abutment, for Crown, Ø 4.5mm, GH 1.5mm, Ceramicor®/POM	16
062.4430	RB/WB Gold Abutment, for Bridge, Ø 4.5mm, GH 1.5mm, Ceramicor®/POM	16
062.4501	RB/WB Novaloc® ADLC, straight 0°, Ø 3.8mm, GH 1.5mm, TAV	26
062.4502	RB/WB Novaloc® ADLC, straight 0°, Ø 3.8mm, GH 2.5mm, TAV	26
062.4503	RB/WB Novaloc® ADLC, straight 0°, Ø 3.8mm, GH 3.5mm, TAV	26
062.4504	RB/WB Novaloc® ADLC, straight 0°, Ø 3.8mm, GH 4.5mm, TAV	26
062.4505	RB/WB Novaloc® ADLC, straight 0°, Ø 3.8mm, GH 5.5mm, TAV	26
062.4506	RB/WB Novaloc® ADLC, straight 0°, Ø 3.8mm, GH 6.5mm, TAV	26
062.4507	RB/WB Novaloc® ADLC, angled 15°, Ø 3.8mm, GH 2.5mm, TAV	26
062.4508	RB/WB Novaloc® ADLC, angled 15°, Ø 3.8mm, GH 3.5mm, TAV	26
062.4509	RB/WB Novaloc® ADLC, angled 15°, Ø 3.8mm, GH 4.5mm, TAV	26
062.4510	RB/WB Novaloc® ADLC, angled 15°, Ø 3.8mm, GH 5.5mm, TAV	26
062.4511	RB/WB Novaloc® ADLC, angled 15°, Ø 3.8mm, GH 6.5mm, TAV	26
062.4512	RB/WB Novaloc® ADLC, angled 15°, Ø 3.8mm, GH 7.5mm, TAV	26
062.4601	RB/WB Pre-milled Abutment Blank, for Medentika Holder, Ø 11.5mm, TAN	25
062.4602	RB/WB Pre-milled Abutment Blank, for Medentika Holder, Ø 15.8mm, TAN	25
062.4603	RB/WB Pre-milled Abutment Blank, for CARES®, Ø 12mm, TAN	25
062.4605	WB Pre-milled Abutment Blank, for Medentika Holder, Ø 11.5mm, TAN	33
062.4606	WB Pre-milled Abutment Blank, for Medentika Holder, Ø 15.8mm, TAN	33
062.4607	WB Pre-milled Abutment Blank, for CARES®, Ø 12mm, TAN	33
062.47225	RB/WB Screw-ret. Abut., straight, Ø 4.6mm, GH 1.5mm, TAN	19
062.47235	RB/WB Screw-ret. Abut., straight, Ø 4.6mm, GH 2.5mm, TAN	19
062.47245	RB/WB Screw-ret. Abut., straight, Ø 4.6mm, GH 3.5mm, TAN	19
062.47255	RB/WB Screw-ret. Abut., straight, Ø 4.6mm, GH 4.5mm, TAN	19
062.47335	RB/WB Screw-ret. Abut., angled 17°, Ø 4.6mm, GH 3.5mm, TAN	19
062.47345	RB/WB Screw-ret. Abut., angled 17°, Ø 4.6mm, GH 4.5mm, TAN	19
062.47355	RB/WB Screw-ret. Abut., angled 17°, Ø 4.6mm, GH 5.5mm, TAN	19
062.47435	RB/WB Screw-ret. Abut., angled 30°, Ø 4.6mm, GH 3.5mm, TAN	19
062.47445	RB/WB Screw-ret. Abut., angled 30°, Ø 4.6mm, GH 4.5mm, TAN	19
062.47455	RB/WB Screw-ret. Abut., angled 30°, Ø 4.6mm, GH 5.5mm, TAN	19
062.4934	RB/WB Variobase® for Crown, incl. screw, Ø 3.8mm, GH 1.5mm, AH 5.5mm, TAN	18
062.4935	RB/WB Variobase® for Crown, incl. screw, Ø 3.8mm, GH 2.5mm, AH 5.5mm, TAN	18
062.4936	RB/WB Variobase® for Crown, incl. screw, Ø 3.8mm, GH 3.5mm, AH 5.5mm, TAN	18
062.4944	RB/WB Variobase® for Crown, incl. screw, Ø 4.5mm, GH 1.5mm, AH 5.5mm, TAN	18
062.4945	RB/WB Variobase® for Crown, incl. screw, Ø 4.5mm, GH 2.5mm, AH 5.5mm, TAN	18
062.4946	RB/WB Variobase® for Crown, incl. screw, Ø 4.5mm, GH 3.5mm, AH 5.5mm, TAN	18
062.4953	WB Variobase® for Crown, incl. screw, Ø 5.5mm, GH 0.75mm, AH 5.5mm, TAN	31
062.4954	WB Variobase® for Crown, incl. screw, Ø 5.5mm, GH 1.5mm, AH 5.5mm, TAN	31
062.4961	RB/WB Variobase® for Bridge/Bar Cylindrical, incl. screw and Cement. Aid, Ø 4.5mm, GH 1.5 mm, AH 3.5mm, TAN/POM	18
062.4971	WB Variobase® for Crown AS, incl. screw, Ø 5.5mm, AH 5.5mm, GH 1.5mm, TAN	31
062.4972	WB Variobase® for Crown AS, incl. screw, Ø 4.5mm, AH 5.5mm, GH 1.5mm, TAN	18
062.4981	RB/WB Variobase® C, Ø 3.8mm, GH 1.5mm, TAN	18
062.4982	RB/WB Variobase® C, Ø 4.5mm, GH 1.5mm, TAN	18
062.4983	WB Variobase® C, Ø 5.5mm, GH 1.5mm, TAN	31
062.8410	WB Gold Abutment, for Crown, Ø 5.5mm, GH 1.5mm, Ceramicor®/POM	32
064.41005	RB Closure Cap, H 0.4mm, Ti	7
064.42025	RB/WB Healing Abutment, Crown, Ø 4mm, GH 1.5mm, AH 2mm, Ti	13



Index by item number

Art.No.	Article	Page
064.42035	RB/WB Healing Abutment, Crown, Ø 4mm, GH 1.5mm, AH 4mm, Ti	13
064.42045	RB/WB Healing Abutment, Crown, Ø 4mm, GH 2.5mm, AH 2mm, Ti	13
064.42055	RB/WB Healing Abutment, Crown, Ø 4mm, GH 2.5mm, AH 4mm, Ti	13
064.42065	RB/WB Healing Abutment, Crown, Ø 4mm, GH 3.5mm, AH 2mm, Ti	13
064.42075	RB/WB Healing Abutment, Crown, Ø 4mm, GH 3.5mm, AH 4mm, Ti	13
064.42125	RB/WB Healing Abutment, Crown, Ø 5mm, GH 1.5mm, AH 2mm, Ti	13
064.42135	RB/WB Healing Abutment, Crown, Ø 5mm, GH 1.5mm, AH 4mm, Ti	13
064.42145	RB/WB Healing Abutment, Crown, Ø 5mm, GH 2.5mm, AH 2mm, Ti	13
064.42155	RB/WB Healing Abutment, Crown, Ø 5mm, GH 2.5mm, AH 4mm, Ti	13
064.42165	RB/WB Healing Abutment, Crown, Ø 5mm, GH 3.5mm, AH 2mm, Ti	13
064.42175	RB/WB Healing Abutment, Crown, Ø 5mm, GH 3.5mm, AH 4mm, Ti	13
064.42225	RB/WB Healing Abutment, Crown, Ø 6.5mm, GH 1.5mm, AH 2mm, Ti	14
064.42235	RB/WB Healing Abutment, Crown, Ø 6.5mm, GH 1.5mm, AH 4mm, Ti	14
064.42245	RB/WB Healing Abutment, Crown, Ø 6.5mm, GH 2.5mm, AH 2mm, Ti	14
064.42255	RB/WB Healing Abutment, Crown, Ø 6.5mm, GH 2.5mm, AH 4mm, Ti	14
064.42265	RB/WB Healing Abutment, Crown, Ø 6.5mm, GH 3.5mm, AH 2mm, Ti	14
064.42275	RB/WB Healing Abutment, Crown, Ø 6.5mm, GH 3.5mm, AH 4mm, Ti	14
064.42325	RB/WB Healing Abutment, Bridge/Bar, Ø 5mm, GH 1.5mm, AH 2mm, Ti	14
064.42335	RB/WB Healing Abutment, Bridge/Bar, Ø 5mm, GH 1.5mm, AH 4mm, Ti	14
064.42345	RB/WB Healing Abutment, Crown, Ø 7.5mm, GH 2.5mm, AH 2mm, Ti	14
064.42355	RB/WB Healing Abutment, Crown, Ø 7.5mm, GH 2.5mm, AH 4mm, Ti	14
064.42365	RB/WB Healing Abutment, Crown, Ø 7.5mm, GH 3.5mm, AH 2mm, Ti	14
064.42375	RB/WB Healing Abutment, Crown, Ø 7.5mm, GH 3.5mm, AH 4mm, Ti	14
064.43225	RB/WB Immediate Temporary Abutment, crown, Ø 3.8mm, GH 1.5mm, TAN	15
064.43235	RB/WB Immediate Temporary Abutment, crown, Ø 3.8mm, GH 2.5mm, TAN	15
064.43245	RB/WB Immediate Temporary Abutment, crown, Ø 3.8mm, GH 3.5mm, TAN	15
064.43325	RB/WB Immediate Temporary Abutment, crown, Ø 4.5mm, GH 1.5mm, TAN	15
064.43335	RB/WB Immediate Temporary Abutment, crown, Ø 4.5mm, GH 2.5mm, TAN	15
064.43345	RB/WB Immediate Temporary Abutment, crown, Ø 4.5mm, GH 3.5mm, TAN	15
064.4352	RB/WB Temporary Abutment, Bridge, Ø 4.5mm, GH 1.5mm, AH 5.5mm, TAN	15
064.4361	RB/WB Temporary Abutment, Ø 3.8mm, GH 1.5mm, VITA CAD-Temp®/TAN	15
064.4362	RB/WB Temporary Abutment, for crown, Ø 3.8mm, GH 1.5mm, TAN	15
064.4363	RB/WB Temporary Abutment, for crown, Ø 3.8mm, GH 2.5mm, TAN	15
064.4364	RB/WB Temporary Abutment, Crown, Ø 3.8mm, GH 3.5mm, TAN	15
064.4371	RB/WB Temporary Abutment, Ø 4.5mm, GH 1.5mm, VITA CAD-Temp®/TAN	15
064.4372	RB/WB Temporary Abutment, for crown, Ø 4.5mm, GH 1.5mm, TAN	15
064.4373	RB/WB Temporary Abutment, for crown, Ø 4.5mm, GH 2.5mm, TAN	15
064.4374	RB/WB Temporary Abutment, Crown, Ø 4.5mm, GH 3.5mm, TAN	15
064.4382	RB/WB Temporary Abutment, for crown, Ø 6mm, GH 2.5mm, TAN	15
064.4383	RB/WB Temporary Abutment, for crown, Ø 6mm, GH 3.5mm, TAN	15
064.4390	WB Temporary Abutment, Ø 5.5mm, GH 1.5mm, VITA CAD-Temp®/TAN	31
064.4391	WB Temporary Abutment, for crown, Ø 5.5mm, GH 0.75mm, TAN	31
064.4392	WB Temporary Abutment, for crown, Ø 5.5mm, GH 1.5mm, TAN	31
064.81025	WB Closure Cap, H 0.5mm, Ti	9
064.82015	WB Healing Abutment, Ø 6mm, GH 0.75mm, AH 2mm, Ti	30
064.82025	WB Healing Abutment, Ø 6mm, GH 0.75mm, AH 4mm, Ti	30
064.82035	WB Healing Abutment, Ø 7.5mm, GH 0.75mm, AH 2mm, Ti	30
064.82045	WB Healing Abutment, Ø 7.5mm, GH 0.75mm, AH 4mm, Ti	30
064.82125	WB Healing Abutment, Ø 6mm, GH 1.5mm, AH 2mm, Ti	30
064.82135	WB Healing Abutment, Ø 6mm, GH 1.5mm, AH 4mm, Ti	30
064.82145	WB Healing Abutment, Ø 7.5mm, GH 1.5mm, AH 2mm, Ti	30
064.82155	WB Healing Abutment, Ø 7.5mm, GH 1.5mm, AH 4mm, Ti	30
065.0000	X-ray Reference Foil, for BLX Implants	36
065.0007	RB/WB Abutment-Removal Screw, TAN	40
065.0008	Removal Tool, for BLX Basal Screw, left-hand, L 27mm, stainless steel	40
065.0009	Removal Tool, for BLX Basal Screw, left-hand, L 21mm, stainless steel	40
065.0014	RB/WB Burn-out Coping, for Variobase® for Crown, Ø 3.8mm, AH 5.5mm, POM	18
065.0015	RB/WB Burn-out Coping, for Variobase® for Crown, Ø 4.5mm, AH 5.5mm, POM	18
065.0016	WB Burn-out Coping, for Variobase® for Crown, Ø 5.5mm, AH 5.5mm, POM	31
065.0017	RB/WB Burn-out Coping, for Variobase® for Bridge/Bar, Ø 4.5mm, AH 3.5mm, POM	18
065.0017V4	RB/WB Burn-out Coping, for Variobase® for Bridge/Bar, Ø 4.5mm, AH 3.5mm, POM	18
065.0018	RB/WB Burn-out Coping, for Variobase® for Crown AS, 25°, Ø 4.5mm, AH 5.5mm, POM	18
065.0019	WB Burn-out Coping, for Variobase® for Crown AS, 25°, Ø 5.5mm, AH 5.5mm, POM	31
065.0021	RB Implant Analog, L 12mm, TAN	12
065.0022	WB Implant Analog, L 12mm, TAN	29
065.0023	RB Repositionable Implant Analog, stainless steel	12



Index by item number

Art.No.	Article	Page
065.0024	WB Repositionable Implant Analog, stainless steel	29
065.0031	RB Impression Post Open Tray, short, incl. guide screw, L 16.5mm, TAN	12
065.0032	WB Impression Post Open Tray, short, incl. guide screw, L 16.5mm, TAN	29
065.0033	RB Impression Post Open Tray, long, incl. guide screw, L 24mm, TAN	12
065.0034	WB Impression Post Open Tray, long, incl. guide screw, L 24mm, TAN	29
065.0035	CARES® RB/WB Mono Scanbody, Ø 3.8mm, H 10mm PEEK/TAN	12, 29
065.0036	RB/WB Basal Screw, TAN	15, 16, 16, 17, 18, 19, 25, 26, 31, 31, 32, 33
065.0037	RB/WB Basal Screw AS, L 6.5mm, TAN	17, 18, 31
065.0038	ScanPost S RB/WB L, TAN	12, 29
065.4310	RB Impression Post Closed Tray, incl. guide screw, L 13mm, TAN	12
065.4810	WB Impression Post Closed Tray, incl. guide screw, L 13mm, TAN	29
066.00255	BLX Guiding Cylinder for Bone Profiler, Ø 2.9mm, L 10.8mm, TAN	38
066.1100	BLX Torque Control Device, for Ratchet, surgical, stainless steel	39
066.1301	X Pilot VeloDrill, guided, Ø 2.2mm, short, stainless steel	37, 41
066.1302	X VeloDrill, guided, Ø 2.8mm, short, stainless steel	37, 41
066.1303	X VeloDrill, guided, Ø 3.2mm, short, stainless steel	37, 41
066.1304	X VeloDrill, guided, Ø 3.5mm, short, stainless steel	37, 41
066.1305	X VeloDrill, guided, Ø 3.7mm, short, stainless steel	37, 41
066.1306	X VeloDrill, guided, Ø 4.2mm, short, stainless steel	37, 41
066.1307	X VeloDrill, guided, Ø 4.7mm, short, stainless steel	37, 41
066.1308	X VeloDrill, guided, Ø 5.2mm, short, stainless steel	37, 41
066.1309	X VeloDrill, guided, Ø 6.2mm, short, stainless steel	37, 41
066.1501	X Pilot VeloDrill, guided, Ø 2.2mm, medium, stainless steel	41
066.1502	X VeloDrill, guided, Ø 2.8mm, medium, stainless steel	41
066.1503	X VeloDrill, guided, Ø 3.2mm, medium, stainless steel	41
066.1504	X VeloDrill, guided, Ø 3.5mm, medium, stainless steel	41
066.1505	X VeloDrill, guided, Ø 3.7mm, medium, stainless steel	41
066.1506	X VeloDrill, guided, Ø 4.2mm, medium, stainless steel	41
066.1507	X VeloDrill, guided, Ø 4.7mm, medium, stainless steel	41
066.1508	X VeloDrill, guided, Ø 5.2mm, medium, stainless steel	41
066.1509	X VeloDrill, guided, Ø 6.2mm, medium, stainless steel	41
066.1701	X Pilot VeloDrill, guided, Ø 2.2mm, long, stainless steel	37, 41
066.1702	X VeloDrill, guided, Ø 2.8mm, long, stainless steel	37, 41
066.1703	X VeloDrill, guided, Ø 3.2mm, long, stainless steel	37, 41
066.1704	X VeloDrill, guided, Ø 3.5mm, long, stainless steel	37, 41
066.1705	X VeloDrill, guided, Ø 3.7mm, long, stainless steel	37, 41
066.1706	X VeloDrill, guided, Ø 4.2mm, long, stainless steel	37, 41
066.1707	X VeloDrill, guided, Ø 4.7mm, long, stainless steel	37, 41
066.2000	Implant Depth Gauge, for Ø 2.2/2.8mm, TAN	38
066.4000	Surgical Handle, for TorcFit™ Implant Driver, stainless steel	39
066.4101	BLX Implant Driver for handpiece, short, L 21mm, stainless steel	39
066.4102	BLX Implant Driver for handpiece, long, L 31mm, stainless steel	39
066.4107	TorcFit™ Implant Driver for handpiece, medium, L 26mm, stainless steel	39
066.4108	TorcFit™ Implant Driver for handpiece, extra long, L 36mm, stainless steel	39
066.4201	BLX Implant Driver for ratchet, short, L 21mm, stainless steel	39
066.4202	BLX Implant Driver for ratchet, long, L 31mm, stainless steel	39
066.4205	TorcFit™ Implant Driver for ratchet, short, screw-retained, stainless steel	39
066.4206	TorcFit™ Implant Driver for ratchet, long, screw-retained, stainless steel	39
066.4207	TorcFit™ Implant Driver for ratchet, medium, L 26mm, stainless steel	39
066.4401	BLX Implant Driver, guided, for ratchet, stainless steel	42
066.4403	TorcFit™ BLX Guided Implant Driver, for handpiece, stainless steel	42
066.4404	TorcFit™ BLX Guided Implant Driver, for ratchet, stainless steel	42
2010.101-NOV	Novaloc® Equipment Box with 3 Instruments	28
2010.601-NOV	Novaloc® Processing Package titanium, 2 pieces	27
2010.611-NOV	Novaloc® Processing Package PEEK, 2 pieces	27
2010.701-NOV	Novaloc® Matrix housing, titanium, (incl. Processing Insert), 4 pieces	27
2010.702-NOV	Novaloc® Matrix housing, PEEK, (incl. black Processing insert), 4 pieces	27
2010.703-NOV	Novaloc® Matrix Housing – Extended, (incl. Processing insert), 4 pieces	27
2010.710-NOV	Novaloc® Retention insert red, (extra-light), 4 pieces	27
2010.711-NOV	Novaloc® Retention insert white, (light), 4 pieces	27
2010.712-NOV	Novaloc® Retention insert yellow, (medium), 4 pieces	27
2010.713-NOV	Novaloc® Retention insert green, (strong), 4 pieces	27
2010.714-NOV	Novaloc® Retention insert blue, (extra-strong), 4 pieces	27
2010.715-NOV	Novaloc® Retention insert black, (ultra-strong), 4 pieces	27
2010.720-NOV	Novaloc® Model Analog – Angled 15°, red, 4 pieces	27
2010.721-NOV	Novaloc® Model Analog blue, 4 pieces	27



Index by item number

Art.No.	Article	Page
2010.722-NOV	Novaloc® Impression Coping, red, 4 pieces	27
2010.723-NOV	Novaloc® Block Out Spacer, white, 4 pieces	28
2010.724-NOV	Novaloc® Processing Collar, white, 10 pieces	28
2010.725-NOV	Novaloc® Processing Insert, white, 4 pieces	28
2010.731-NOV	Novaloc® Processing Insert Removal Instrument, (blue)	28
2010.741-NOV	Novaloc® Retention Insert Instrument, (brown)	28
2010.751-NOV	Novaloc® Matrix Housing Extraction Instrument, (grey)	28



International Headquarters

Institut Straumann AG

Peter Merian-Weg 12

CH-4002 Basel, Switzerland

Phone +41 (0)61 965 11 11

Fax +41 (0)61 965 11 01

www.straumann.com

© Institut Straumann AG, 2022. All rights reserved.

Straumann® and/or other trademarks and logos from Straumann® mentioned herein are the trademarks or registered trademarks of Straumann Holding AG and/or its affiliates. All rights reserved.

450.012/en/E/00 09/22