

axiomX3[®]

OLTRE OGNI FRONTIERA



Axiom X3[®]
Catalogo
chirurgico 2022

Anthogyr
A Straumann Group Brand

axiomX3[®]

Nuovo design dell'impianto brevettato nell'universo Axiom[®], per affrontare nuove sfide nell'implantologia

- 1 impianto per tutte le densità ossee
- Ampia scelta di diametri, da 3.4 mm a 6.4 mm
- Lunghezza da 6.5 mm a 18 mm

DESIGN UNICO BREVETTATO

- Progettato per un ancoraggio universale in tutte le densità ossee
- Protocolli adattati per i trattamenti immediati



NESSUN MASCHIATORE, MENO PASSAGGI DI FRESATURA

- Maggiore efficienza
- Conservazione ossea



AXIOM[®] BONE LEVEL CONNESSIONE PROTESICA SINGOLA

- Gamma protesica comune per i profili X3, REG e PX
- Pronta disponibilità e flessibilità protesica

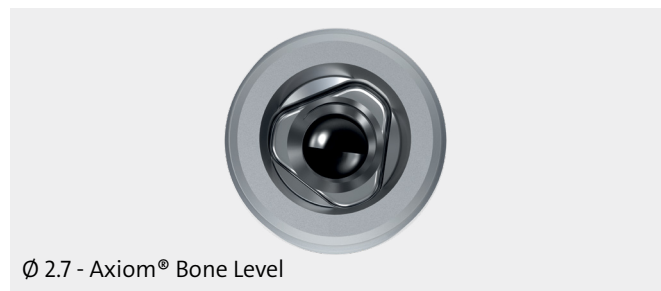

KIT CHIRURGICO SINGOLO AXIOM[®] MULTI LEVEL[®] COMUNE

- Libertà di scelta
- Implementazione semplice



Altre informazioni a p.6.

CONNESSIONE CONICA SINGOLA

Comune per tutti gli impianti Axiom® Bone Level profili X3, REG e PX

DIAMETRO DEL COLLO RIDOTTO*

Minore stress corticale

LUNGHEZZA ALTERNATA DELLA FILETTATURA

Conservazione ossea
Minore sforzo di inserimento
Tutte le densità ossee

FILETTATURE SOTTILI

Inserimento semplificato

3 SCANALATURE DI TAGLIO BIDIREZIONALI

Inserimento dinamico per tutta l'altezza dell'impianto
Correzione dell'asse di inserimento

PROFILO CONICO

Stabilità primaria ottimale
Osso morbido

APICE SOTTILE

Inserimento efficiente in situazioni post-estrattive

APICE ARROTONDATO

Protezione della membrana del seno

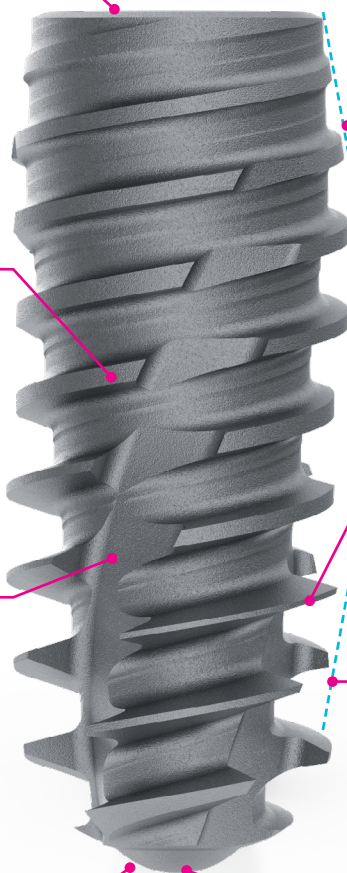

* Da diametro 4.0 mm.

Gamma di impianti

NUOVO





























Vite di copertura
inclusa



OPIM100*

AXIOM X3®

NUOVI DIAMETRI

	Ø 3.4 mm ●	Ø 4 mm ●	Ø 4.6 mm ○	Ø 5.2 mm ●	Ø 5.8 mm ●	Ø 6.4 mm ●
6.5 mm	-	 XT40060	 XT46060	 XT52060	 XT58060	 XT64060
8 mm	 XT34080	 XT40080	 XT46080	 XT52080	 XT58080	 XT64080
10 mm	 XT34100	 XT40100	 XT46100	 XT52100	 XT58100	 XT64100
12 mm	 XT34120	 XT40120	 XT46120	 XT52120	 XT58120	-
14 mm	 XT34140	 XT40140	 XT46140	-	-	-
16 mm	 XT34160	 XT40160	-	-	-	-
18 mm	 XT34180	 XT40180	-	-	-	-

*Chiave chirurgica manuale

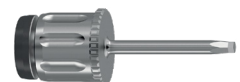





































OPCS100

Viti di guarigione STERILE



AXIOM® BONE LEVEL*

ALTEZZA GENGIVALE	Ø 3.4 mm		Ø 4.0 mm		Ø 5.0 mm		Ø 6.0 mm	
	ALTEZZA CORONALE		ALTEZZA CORONALE		ALTEZZA CORONALE		ALTEZZA CORONALE	
	2 mm	1 mm	2 mm	1 mm	2 mm	1 mm	2 mm	1 mm
0.75 mm	-	-	 OPHS400	 OPHSF400	 OPHS500	 OPHSF500	-	-
1.5 mm	 OPHS310	 OPHSF310	 OPHS410	 OPHSF410	 OPHS510	 OPHSF510	 OPHS610	 OPHSF610
2.5 mm	 OPHS320	 OPHSF320	 OPHS420	 OPHSF420	 OPHS520	 OPHSF520	 OPHS620	 OPHSF620
3.5 mm	 OPHS330	 OPHSF330	 OPHS430	 OPHSF430	 OPHS530	 OPHSF530	 OPHS630	 OPHSF630
4.5 mm	 OPHS340*	 OPHSF340*	 OPHS440*	 OPHSF440*	 OPHS540*	 OPHSF540*	 OPHS640*	 OPHSF640*

Per le componenti protesiche su Axiom X3®, fare riferimento al catalogo Axiom® Multi Level®. I riferimenti superiori sono indicati in blu.

MARCATURA A LASER SULLA TESTA DELLA VITE

GH (mm)	0.75	1.5	2.5	3.5	4.5
H (mm)	0	1	2	3	4
Ø 3.4					
Ø 4.0					
Ø 5.0					
Ø 6.0					

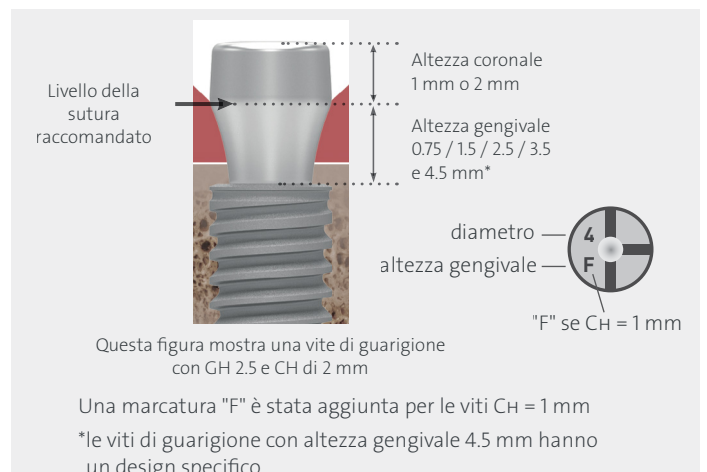

* Gamma comune per i profili X3, REG e PX.

Kit chirurgico e strumenti

**1 UNICO KIT CHIRURGICO COMPATTO
PER TUTTI GLI IMPIANTI AXIOM® BONE LEVEL
E AXIOM® TISSUE LEVELPROFILI X3, REG E PX**

NUOVO KIT

- + Semplicità
- + Integrazione perfetta nell'ecosistema Axiom®
- + Libertà e flessibilità
 - Possibilità di adattare la scelta dell'impianto durante l'intervento
- + Uso intuitivo
 - Soluzioni complementari



- + Punte rivestite biocompatibili dure
- + Trattamento superficiale che ottimizza la visibilità delle marcature di profondità nel cavo orale

Axiom® Multi Level® Kit chirurgico

NUOVO KIT

- Profili Axiom X3® + REG e PX
- Comune per Bone e Tissue Level
- Include le nuove frese per Axiom X3®
Ø 5.8 e 6.4 mm

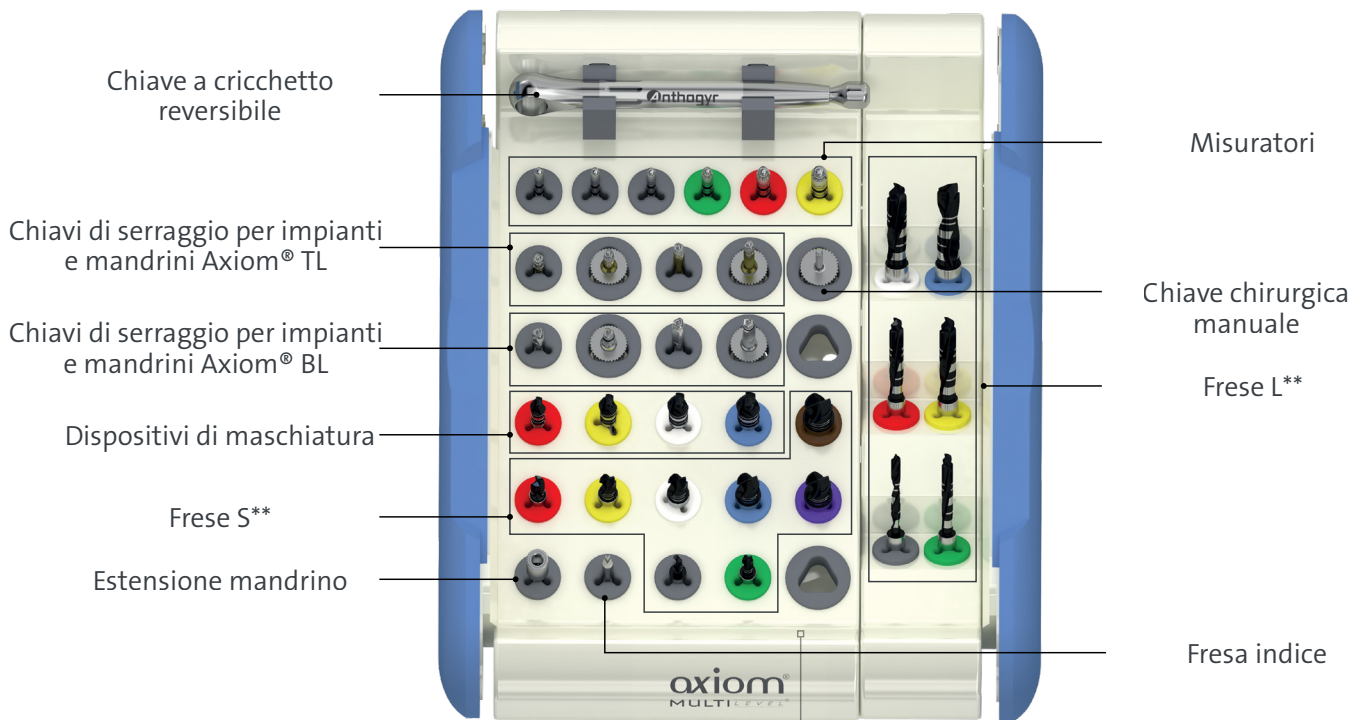











+ Indice per valutare la lunghezza del foro di fresatura



















+ Fornito con 2 gommini di regolazione





*Frese S : Frese CORTE. **Frese L: Frese LUNGHE.







Kit chirurgici, strumenti e accessori per Axiom X3®

		AXIOM® MULTI LEVEL®*
Axiom® Multi Level® kit chirurgico	NUOVO  INMODOPS3L	Per tutti i diametri di Axiom X3® da Ø 3.4 a 6.4 mm
Kit chirurgico Axiom® Multi Level® senza contenuto	NUOVO INMODOPS3LV	
Axiom® Multi Level® kit chirurgico	 INMODOPS3	Per Axiom X3® diametri da Ø 3.4 a 5.2 mm
Kit chirurgico Axiom® Multi Level® senza contenuto	INMODOPS3V	
Kit aggiornamento per kit chirurgico Axiom® Multi Level® Per consentire l'inserimento dei diametri 5.8 e 6.4	NUOVO PACKUPOPS3L	Contenuti: 1 kit chirurgico senza contenuto rif INMODOPS3LV + 2 frese grandi OPFE54S e OPFE60S
Chiave chirurgica manuale	 OPCS100	
Estensione mandrino	 INEXM	
Chiave a mandrino	 INCPM	
Chiave a cricchetto reversibile	 INCC	
Chiave dinamometrica chirurgica*	 INCCDC	Da 0 a 80 N.cm
Axiom® Misuratore di profondità dop- pia funzione*	 OPJC001	
Guida per fresa	 INGPPA	
Guida per fresa angolata*	 INGFA	

AXIOM® MULTI LEVEL®			
	DIAMETRO	CORTA	LUNGA
Fresa a rosetta*		 INFB20	
Fresa indice	1.5 mm	 OPPO15150	
Fresa Lindemann*	2.0 mm	 OPR20	
Fresa iniziale	2.0 mm	 OPFI20S	 OPFI20L
Fresa a gradini	2.0/ 2.4 mm ●	 OPFE24S	 OPFE24L
	2.4/ 3.0 mm ●	 OPFE30S	 OPFE30L
	3.0/ 3.6 mm ●	 OPFE36S	 OPFE36L
	3.6/ 4.2 mm ○	 OPFE42S	 OPFE42L
	4.2/ 4.8 mm ●	 OPFE48S	 OPFE48L
	4.8 / 5.4 mm ●	 OPFE54S**	-
	5.4 / 6.0 mm ●	 OPFE60S**	-











* Non incluso nei kit INMODOPS3 e INMODOPS3L. ** Solo nel kit INMODOPS3L.

<p>Confezione da 6 frese a gradino</p>	<p>Iniziale</p> 	 <p>OPFES-6</p>	 <p>OPFEL-6</p>
<p>Confezione da 12 frese a gradino (6 XS + 6 XL)</p>	<p>Iniziale</p> 	 <p>OPFESL-12</p>	

	DIAMETRO	AXIOM® MULTI LEVEL®**
Misuratore	2.0 mm	 <p>OPJD020</p>
	2.4 mm 	 <p>OPJD024</p>
	3.0 mm 	 <p>OPJD030</p>
	3.6 mm 	 <p>OPJD036</p>
	4.2 mm  *	 <p>OPJD042</p>
	4.8 mm  *	 <p>OPJD048</p>
	5.4 mm  *	<p>NUOVO</p>  <p>OPJD054</p>
	6.0 mm  *	<p>NUOVO</p>  <p>OPJD060</p>

*Non incluso nei kit INMODOPS3 e INMODOPS3L.

**AXIOM® BONE LEVEL - X3 - REG - PX DESIGN
AXIOM® TISSUE LEVEL - REG - DESIGN PX.

AXIOM® MULTI LEVEL®**			
	CORTO	MEDIO	LUNGO
Impianti Axiom® BL Mandrini	 OPMV180 23 mm	 OPMV215* 27 mm	 OPMV250 32 mm
Chiave manuale per impianto Axiom® BL	 OPCV060 21 mm	 OPCV110* 27 mm	 OPCV160 31 mm
Axiom® BL chiave manuale per vite impianto (con cacciavite)*		 INPIM	 INPIL
Mandrino per estrazione viti*	 INMDS		 INMDL

Pellicole di calibrazione / mascherine radiografiche

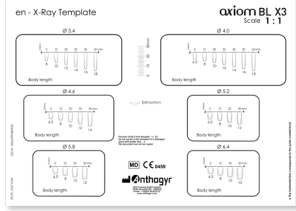
AXIOM X3®	
Axiom X3®	 <p>an - X-Ray Template</p> <p>axiom BL X3 Scale 1 : 1</p> <p>XTLFC_NOT</p>

* Non incluso nei kit INMODOPS3 e INMODOPS3L.



**AXIOM® BONE LEVEL - X3 - REG - PX DESIGN
AXIOM® TISSUE LEVEL - REG - DESIGN PX.

Axiom® Multi Level® Kit stop per frese:

ERGONOMICO E INTUITIVO

- + Semplicità di prelievo della fresa con contrangolo
- + Sistema anticaduta
- + Codifica a colori che semplifica l'identificazione
- + Per tutti gli impianti Axiom® Bone Level e Axiom® Tissue Level



KIT STOP PER FRESE	AXIOM® MULTI LEVEL®*	
Axiom® Multi Level® kit stop per frese Per tutti i diametri di Axiom X3®, da 3.4 a 6.4 mm 18 stop per frese corte (S) e 24 lunghe (L)	NUOVO	 INKITOPDSL
Axiom® Multi Level® box stop per frese per 42 stop per frese (vuoto)	NUOVO	INKITOPDSL
Axiom® Multi Level® kit stop per frese Per diametri da 3.4 a 5.2 mm 12 stop per frese corti (S) e 24 lunghi (L)		 INKITOPDS
Axiom® Multi Level® box per 36 stop per frese (vuoto)		INKITOPDSV

Diametro fresa	STOP PER FRESE S						STOP PER FRESE L			
					NUOVO 	NUOVO 				
Lunghezza impianto	Ø 2.0 / 2.4 / 3.0 mm	Ø 3.6 mm	Ø 4.2 mm	Ø 4.8 mm	Ø 5.4 mm	Ø 6.0 mm	Ø 2.0 / 2.4 / 3.0 mm	Ø 3.6 mm	Ø 4.2 mm	Ø 4.8 mm
6.5 mm	OPB3006C Ø 3.0 mm	OPB3606C Ø 3.6 mm	OPB4206C Ø 4.2 mm	OPB4806C Ø 4.8 mm	OPB5406C Ø 5.4 mm	OPB6006C Ø 6.0 mm	OPB3006L Ø 3.0 mm	OPB3606L Ø 3.6 mm	OPB4206L Ø 4.2 mm	OPB4806L Ø 4.8 mm
8 mm	OPB3008C Ø 3.0 mm	OPB3608C Ø 3.6 mm	OPB4208C Ø 4.2 mm	OPB4808C Ø 4.8 mm	OPB5408C Ø 5.4 mm	OPB6008C Ø 6.0 mm	OPB3008L Ø 3.0 mm	OPB3608L Ø 3.6 mm	OPB4208L Ø 4.2 mm	OPB4808L Ø 4.8 mm
10 mm	OPB3010C Ø 3.0 mm	OPB3610C Ø 3.6 mm	OPB4210C Ø 4.2 mm	OPB4810C Ø 4.8 mm	OPB5410C Ø 5.4 mm	OPB6010C Ø 6.0 mm	OPB3010L Ø 3.0 mm	OPB3610L Ø 3.6 mm	OPB4210L Ø 4.2 mm	OPB4810L Ø 4.8 mm
12 mm							OPB3012L Ø 3.0 mm	OPB3612L Ø 3.6 mm	OPB4212L Ø 4.2 mm	OPB4812L Ø 4.8 mm
14 mm							OPB3014L Ø 3.0 mm	OPB3614L Ø 3.6 mm	OPB4214L Ø 4.2 mm	OPB4814L Ø 4.8 mm
16 mm							OPB3016L Ø 3.0 mm	OPB3616L Ø 3.6 mm		
18 mm							OPB3018L Ø 3.0 mm	OPB3618L Ø 3.6 mm		

*AXIOM® BONE LEVEL - X3 - REG - DESIGN PX
AXIOM® TISSUE LEVEL - REG - DESIGN PX



C218_IT - 2022-02

Crediti fotografici: Anthogyr, Getty images

Tutti i diritti riservati - Il prodotto può differire dall'immagine mostrata.

www.anthogyr.it

Follow us!

